



MEGABLOK®

EQUIPAMIENTO DE COLECTIVIDADES

EQUIPMENT FOR COLLECTIVITIES / EQUIPEMENT POUR COLLECTIVITES / EQUIPAMENTO DE COLECTIVIDADES

ANIVERSARIO **15**



NUEVAS INSTALACIONES

NEW FACILITIES
DE NOUVELLES INSTALLATIONS
NOVAS INSTALAÇÕES



CERTIFICADOS Y HOMOLOGACIONES

CERTIFICATES AND HOMOLOGATIONS
 CERTIFICATS ET HOMOLOGATIONS
 CERTIFICAÇÕES E HOMOLOGAÇÕES



Pg. 104-115



Pg. 120-129

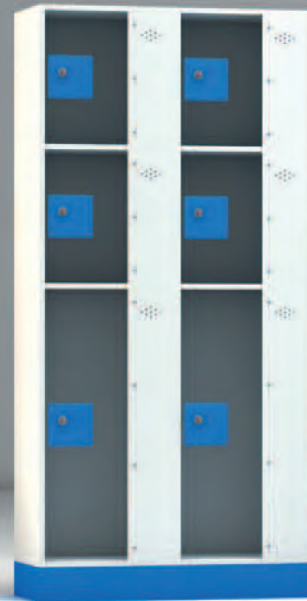

Pg. 130-131



Pg. 12-37



Pg. 38-55



Pg. 56-61

Pg. 132-137



Pg. 96-99

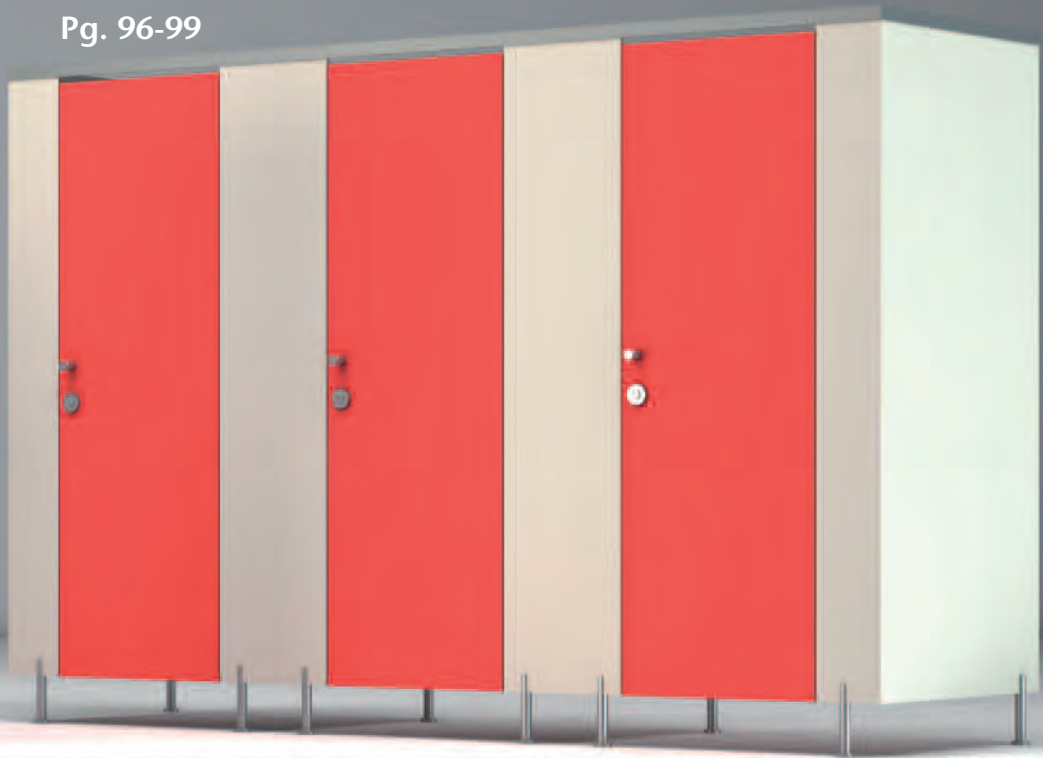

Pg. 62-69



Pg. 70-79



Pg. 80-95



Pg. 116-117

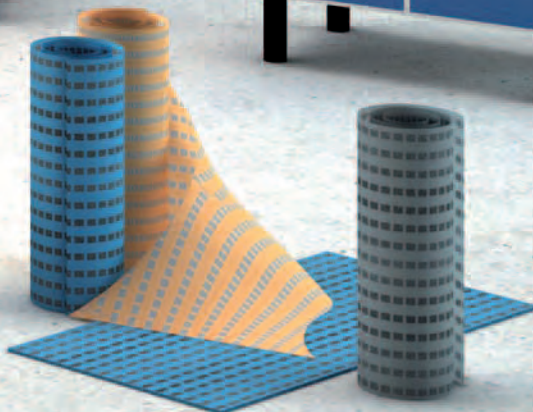

Pg. 138

LEYENDA Y SIMBOLOGÍA /

SIMBOLS LEGEND
LEGENDE DES SYMBOLES
LEGENDA SIMBOLOGIA

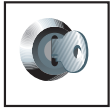

Cerradura de llave.
Standard key lock.
Serrure standard à clé.
Fechadura standard de chave.



Gran resistencia.
Great resistance.
Très résistant.
Muito resistente.



Sin tornillos.
Without screws.
Sans vis.
Sem parafusos.



Sistema inicial y de extensiones. Sistema modular.
Initial + adds system. Knock-down system.
Système de case départ plus cases suivantes. Vestiaires démontables.
Sistema de cacifo inicial e sucesivos. Cacifos desmontados.



Pata regulable en altura.
Legs adjustable in height.
Pieds réglables en hauteur.
Pés reguláveis em altura.



Cuerpo gris y puertas azul.
Grey body and blue doors.
Corp gris et portes bleu.
Corpo cinza e portas azuis.



Trasera y bandejas galvanizada, no pintadas.
Back panel and shelves are galvanized, not painted.
Partie arrière et tablettes en acier galvanisé, non peint.
Parte de atrás e prateleiras construídas em aço galvanizado, não pintado.



Etiquetero y rosetas de ventilación.
Card holder and vent system.
Porte-étiquette et volets d'aération.
Placa de numeração e ventilação.



Puerta con refuerzo longitudinal y anilla toallero.
Door with longitudinal reinforcement and towel ring.
Porte avec renforcement longitudinal et crochet pour les serviettes.
Porta com reforço longitudinal e gancho para pendurar as toalhas.



Puerta con refuerzo longitudinal.
Door with longitudinal reinforcement.
Porte avec renforcement longitudinal.
Porta com reforço longitudinal.



Bandeja y colgador para perchas.
Shelf and coat rod.
Tablette et tringle porte cintres.
Prateleira e barra para pendurar cabides.



Divisoria vertical.
Vertical center partition.
Séparation verticale.
Divisória vertical.



Barra portaperchas.
Coat rod.
Tringle porte cintres.
Barra para pendurar cabides.



Número puertas.
Number of doors.
Nombres de portes.
Numero de portas.



Llave abisagrada.
Hinged key.
Clés articulés.
Chaves com articulação.



Incluye patas.
Includes legs.
Pieds inclus.
Com pés.



Rosetas de ventilación.
Ventilation rosettes.
Volets d'aération.
Com ventilação.



Etiquetero y tirador integrado.
Card holder and handle in one piece.
Porte-étiquette avec tireur.
Portas com etiqueteiro e com tirador.

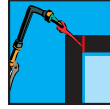

Estructura soldada.
Welded structure.
Structure soudée.
Estrutura soldada.



Sin montaje.
Without assembly.
Pas de montage.
Sem montagem.

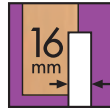

Módulos individuales de 16 mm. de espesor.
Individual modules of 16 mm thickness.
Modules simples épaisseur 16 mm.
Colunas soltas espessura 16 mm.

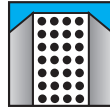

Trasera en tablex perforado y totalmente enmarcada.
Back panel made of perforated tablex and totally framed.
Partie arrière en tablex perforé et totalement encadrée.
Parte de atrás construída em tablex perfurado e totalmente encaixada.



Pintado en Epoxi.
Painted in Epoxy.
Peinture en epoxi.
Pintura em epoxi.

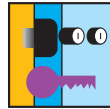

Cerradura de resbalón con bombillo extraíble y llave maestra.
Latch operated lock with removable cylinder and master key.
Serrure à plaquer avec cylindre enlevable et clé passe.
Fechadura de segurança com possibilidade de tirar o cilindro e chave mestre.



Placa de numeración incluida.
Numeration plate included.
Plaque numérique inclus.
Placa de numeração inclusa.



Taquillas fabricadas en tablero compacto de resinas fenólicas.
Lockers manufactured with compact panels made of phenolic resins.
Vestiaires fabriqués en stratifié compact.
Cacifos construídos em resinas fenólicas.



Material de gran resistencia, hidrófugo, ignífugo y antibacteriano.
Material of great resistance, hydrophobic, fire resistant and antibacterial.
Matériel très résistant, hydrofuge, ignifuge et antibactérien.
Material muito resistente, hidrófugo, ignífugo e antibacteriano.



Cantos redondeados.
Rounded edges.
Sans arête vive.
Cantos redondeados.

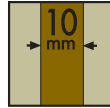

Espesores.
Thicknesses.
Épaisseurs.
Espessura.

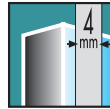

Perfilería estabilizadora de aluminio.
Stabilizing aluminium profiles.
Profils d'aluminium.
Perfilaria de alumínio.



Tornillería y bisagras en acero inoxidable.
Screws and hinges in stainless steel.
Vis et charnières en acier inoxydable.
Parafusos e dobradiças em aço inox.



Estructura en acero inoxidable AISI 304.
Structure made of stainless steel AISI 304.
Structure en acier inoxydable aisi 304.
Estrutura em aço inox aisi 304.



Fabricado en tubo de acero.
Manufactured in steel tube.
Fabriqué en tube d'acier.
Construção em tubo de aço.



Perchas de zamak de triple gancho.
Triple zamak hooks.
Crochets en zamak.
Ganchos triplos de zamak.



Chasis de tubo de acero.
Steel tube chassis.
Structure en tube d'acier soudé.
Estrutura em tubo de aço soldado.

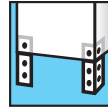

Patas metálicas.
Metal legs.
Pieds en acier.
Pés em aço.



Listones de pino barnizado.
Varnished pine wood slats.
Lames de pin verni.
Assento de pinheiro envernizado.

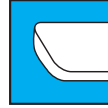

Tablero de resina de polipropileno.
Panel made of polypropylene resin.
Panneau en résine de polypropilène.
Painel de resina de polipropileno.



Color standard: Gris RAL 7035.
Standard colour: Grey RAL 7035.
Couleur standard: gris ral 7035.
Cor standard: cinza ral 7035.

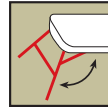

Plegable.
Foldable.
Pliant.
Plegavel.



Se sirve desmontado.
Delivered disassembled.
Fourni démonté.
Fornecemos tudo desmontado.

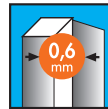

Fabricado en chapa de acero laminado en frío de 0,6 mm de espesor.
Manufactured in cold laminated steel sheet of 0,6 mm thickness.
Fabriqué en tôle d'acier laminée à froid épaisseur 0,6 mm.
Fabricação em chapa de aço laminado em frio espessura 0,6 mm.



Patas de acero.
Steel legs.
Pieds en acier.
Pés em aço.



Fácil instalación de bandejas.
Easy installation of the shelves.
Montage facile des tablettes.
Facil montagem de prateleiras.



Asiento y repisa de fibra de 16 mm.
Seat and shoe rack in wooden fiber of 16 mm thickness.
Assise et étagère pour chaussures en fibre de 16 mm.
Assento e opção para por os sapatos de fibra de 16 mm.



Bandeja con refuerzo longitudinal.
Shelf with longitudinal reinforcement.
Tablettes avec renforcement longitudinal.
Prateleiras com reforço longitudinal.



Asiento y repisa de melamina de 16 mm.
Seat and shoe rack in melamine of 16 mm thickness.
Assise et étagère pour chaussures en mélamine de 16 mm.
Assento e opção para por os sapatos de madeira de tola de 16 mm.

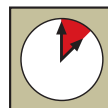

Fácil montaje.
Easy assembly.
Montage facile.
Facil montagem.



Asiento de melamina y repisa de acero.
Seat in melamine and steel shoe rack.
Assise en mélamine et étagère pour chaussures en acier.
Assento de madeira de tola e repisa para os sapatos em aço.



Microtexturado.
Microtextured.
Microtexturé.
Microtexturado.

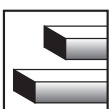

Fabricado en PVC.
Manufactured in PVC.
Fabriqué en PVC.
Fabricação em PVC.

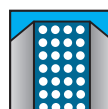

Trasera fenólica de 3 mm. perforada.
Perforated phenolic back panel of 3 mm thickness.
Partie arrière en stratifié compact perforé épaisseur 3 mm.
Parte de atrás fenólica de 3 mm perforada.



Recomendado para ambientes húmedos. Resistente al agua. Waterproof.
Recommended for wet areas. Waterproof.
Recommandé pour les environnements humides.
Recomendado para lugares com humidade. Resistente a água.

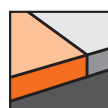

Canteadado PVC.
PVC-Edged.
Finitions en PVC.
Finição em PVC.



No es recomendable para espacios húmedos.
Not recommended for wet spaces.
Pas recommandé pour les environnements humides.
Nao é recomendável para lugares com humidade.

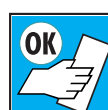

Fácil limpieza.
Easy cleaning.
Nettoyage facile.
Fácil limpeza.

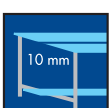

Asiento con lamas de tablero fenólico de 10 mm de espesor y repisa zapatero.
Seat made of phenolic slats of 10 mm thickness and shoe rack.
Assise avec lames en stratifié compact épaisseur 10 mm et étagère pour chaussures.
Assento em fenólico de 10 mm de espessura e opção sapateiro.



Inox.
Stainless steel.
Inox.
Inox.





















Metal.
Metal.
Metal.
Metal.

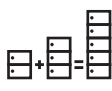

ABS
ABS resin.
Plastique ABS.
Plástico ABS.

LEYENDA Y SIMBOLOGÍA /

SIMBOLS LEGEND
LEGENDE DES SYMBOLES
LEGENDA SIMBOLOGÍA

	ALTURA Height / Hauteur / Altura		CERRADURA DE LLAVE Keyed lock / Serrure à clé / Fechadura de chave
	ANCHURA Width / Largeur / Largura		CERRADURA PARA CANDADO POLIAMIDA Padlockable polyamide lock / Poignée cadenasable en polyamide / Fechadura para cadeado em poliamida
	PROFUNDIDAD Depth / Profondeur / Profundidade		CERRADURA MONEDERO Coin operated-lock / Monnayeur / Fechadura de moedeiro
	ANCHURA PARCIAL Partial width / Largeur partielle / Largura parcial		CERRADURA PARA CANDADO METÁLICO Padlockable metallic lock / Poignée métallique / Fechadura para cadeado em metal
	ANCHURA BANDEJA Width shelf / Largeur de la tablette / Largura da prateleira		PARA ANCLAR A PARED Model to anchor to the wall / Modèle à encastrer dans le mur / Pode se colocar pendurado na parede
	ANCHURA INICIAL Initial width / Largeur «depart» / Largura inicial		INCLUYE TORNILLOS DE UNIÓN Metal screws to join included / Vis d'assemblage incluses / Inclui parafusos para a união
	ANCHURA EXTENSION Adds system width / Largeur «suivant» / Largura extensão		CONSTRUCCIÓN MODULAR Modular construction / Construction modulaire / Construção modular
	N.º DE PUERTAS Numbers of doors Nombre de portes N.º de portas		SERVICIO RÁPIDO (Plazo de entrega: inferior a 2 semanas) Fast service (Delivery time: inferior to 2 weeks) Délai de livraison plus courts (Délai de fabrication 2 semaines) Serviço rápido (Prazo inferior a 2 semanas)
	N.º DE PERCHAS Number of hooks Nombre de pateres N.º de cabides		NOVEDAD New / Nouveau / Novedade
	CAPACIDAD Capacity / Capacité / Capacidade		STOCK (Plazo de entrega: inferior a 1 semana) Stock (Delivery time: inferior to 1 week) Stock (Délai de fabrication 1 semaine) Stock (Prazo inferior a 1 semana)

OPCIONES / OPTIONS OPÇÕES



Pomo en poliamida
(candado opcional)
Padlockable Polyamide Lock
(optional padlock)
Poignée cadassable en
polyamide (cadenas en option)
Fechadura de cadeado em
poliamida



Pomo metálico (candado
combinación opcional)
Padlockable Metallic Lock
(optional combination padlock)
Poignée métallique (cadenas à
combinaison en option)
Fechadura de cadeado em metal
poliamida

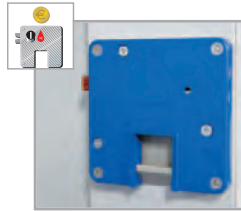

Monedero (moneda retornable). Puertas sin
ventilación ni tarjetero
Coin-operated Lock (coin-return). Doors
without card holder neither vent system
Monnayeur (monnaie réversible). Portes
sans volet d'aération et sans porte-étiquette
Moedeiro (moeda retornável). Portas sem
ventilação nem possibilidade de colocar
cartão de identificação

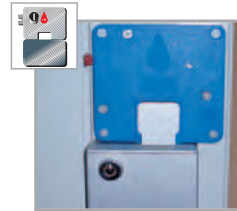

Monedero + cajetín depósito. Puertas sin
ventilación ni tarjetero
Coin-operated Lock + Coin Collect Box (cash
box, non coin-return). Doors without card holder
neither vent system
Monnayeur + tirelire (monnaie non réversible).
Portes sans volet d'aération et sans porte-étiquette
Moedeiro + caixinha para as moedas. Portas sem
ventilação nem possibilidade de colocar cartão de
identificação



Cerradura electrónica de combinación
de 4 dígitos.
Electronic lock combination of 4 digits.
Serrure électronique à combinaison de
4 chiffres.
Fechadura electrónica, combinação de
4 dígitos.



Cerradura de combinación
Combination lock
Serrure à combinaison
Fechadura de combinação



Sobretecho inclinado
Slope Top
Toit incliné
Sobreteto com pequena inclinação



Patas regulables en PVC
Adjustable PVC Legs
Pieds réglables en PVC
Pés reguláveis em altura em PVC



Patas en acero galvanizado
Galvanized steel legs
Pieds en acier galvanisé
Pés em aço galvanizado



Cerradura de proximidad
Lock of proximity
Serrure de proximité
Fechadura de proximidade



Altillo taquilla
Upper small joined locker
Casier en réhausse
Pequeno cacifo para pôr encima do
armário de vestiário

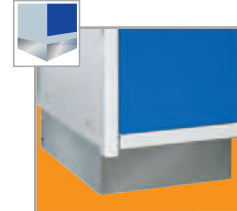

Zócalo inoxidable
Stainless Steel Front Base and
End Base
Socle inoxydable
Soclo inox



Lateral embellecedor
Decorative end panel
Enjoliveur latéral
Lateral de finição

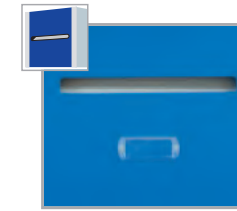

Ranura buzón. Puertas sin ventilación
Mailbox Slot. Doors without vent
system
Rainure pour boîte à lettres. Portes
sans volet d'aération
Obertura para cartas. Portas sem
ventilação

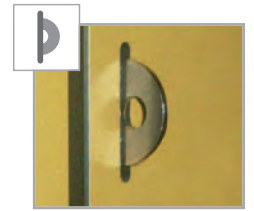

Cierre para candado
Closing for padlock
Fermeture pour cadenas
Fechadura para cadeado



Cerradura de combinación manual
de 4 dígitos y llave de emergencia
Lock of 4 manual digits with
emergency key
Serrure à combinaison manuelle de
4 chiffres et clé de émergence
Fechadura de combinação manual
de 4 dígitos e chave de
emergência



Cerradura de falleba
Lock of shutter-bolt
Serrure d'espagnolette
Fechadura de espagnolette



Cerradura encastrable
Lock encastrable
Serrure encastrable
Fechadura encastrable



Pulsera de nylon
Bracelet of nylon
Bracelet en nylon
Pulseira de náilon



Pulsera elástica
Elastic Bracelet
Bracelet élastique
Pulseira elástica



Espejo
Mirror
Miroir
Espelho

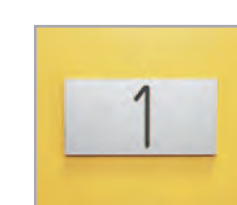

Placa numeración
Numeration plate
Plaque numérique
Placa de numeração





TAQUILLAS MODULARES

DISASSEMBLED LOCKERS
 VESTIAIRES DEMONTABLES
 ARMÁRIOS DE VESTIÁRIO DESMONTÁVEIS

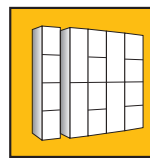

**MICRO
 TEXT**



OPCIONES / OPTIONS / OPTIONS / OPÇÕES

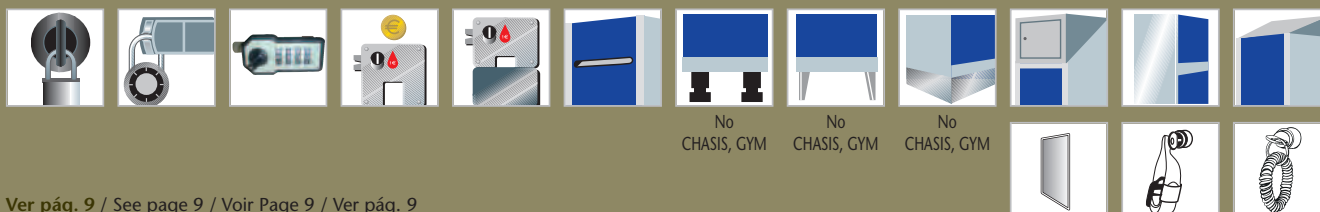

No
 CHASIS, GYM

No
 CHASIS, GYM

No
 CHASIS, GYM

Ver pág. 9 / See page 9 / Voir Page 9 / Ver pág. 9

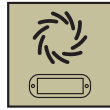
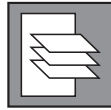
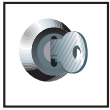

STOCK

NOVEDAD
EW / NOUVEAU /
NOVEDADE

NOVEDAD
EW / NOUVEAU /
NOVEDADE

NOVEDAD
EW / NOUVEAU /
NOVEDADE



COLORES OPCIONALES / OPTIONAL COLOURS / COULEURS EN OPTION / CORES OPCIONAIS

RAL 9010

RAL 6029

RAL 1021

RAL 1017

RAL 3000

RAL 3005

RAL 6034

RAL 5015

RAL 5023

RAL 2004

RAL 7016

RAL 7036

RAL 9006

RAL 9005



TAQUILLAS MODULARES /

DISASSEMBLED LOCKERS
VESTIAIRES DEMONTABLES
ARMÁRIOS DE VESTIÁRIO DESMONTÁVEIS



AV-25/1 COD. 32501	AV-25/2 COD. 32505	AV-25/3 COD. 32503	AV-25/4 COD. 32504	AV-30/1 COD. 33001	AV-30/2 COD. 33002	AV-30/3 COD. 33003	AV-30/4 COD. 33004
19,2 • 0,26	32,4 • 0,49	45,5 • 0,72	58,7 • 0,95	21,5 • 0,30	37,0 • 0,58	52,5 • 0,85	68,0 • 1,13



SERIE AV

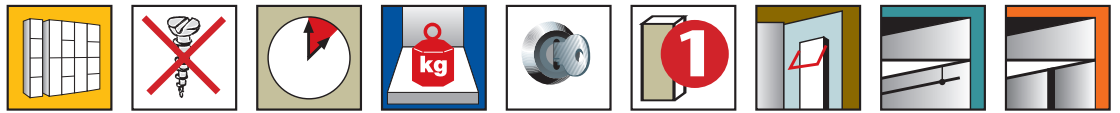

AV-40 / AV-45

STOCK

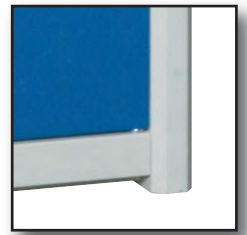

(AV-25, AV-30, AV-35)



(AV-40, AV-45)



SERIE AV	↑	↔	kg	M ³	↔	kg	M ³	↗
AV-25	1800	280	19,2	0,096	250	13,2	0,077	510
AV-30	1800	330	21,5	0,096	300	15,5	0,077	510
AV-35	1800	380	22,8	0,096	350	16,8	0,077	510
AV-40	1800	430	26,5	0,096	400	20,5	0,077	510
AV-45	1800	480	27,9	0,096	450	21,9	0,077	510

AV-35/1
COD. 33501

AV-35/2
COD. 33502

AV-35/3
COD. 33503

AV-40/1
COD. 34001

AV-40/2
COD. 34002

AV-40/3
COD. 34003

AV-45/1
COD. 34501

AV-45/2
COD. 34502

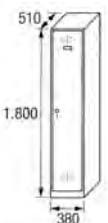

22,8 • 0,35



39,6 • 0,67

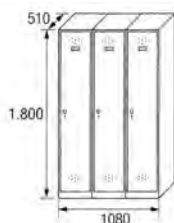

56,4 • 0,99

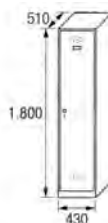

26,5 • 0,39



47,0 • 0,76

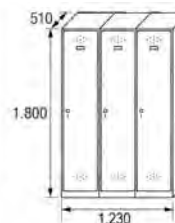

67,5 • 1,13

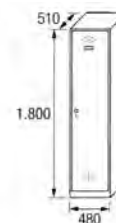

27,9 • 0,44



49,8 • 0,85

Unidades en milímetros / Units in milimeters / Unités en milimètres / Unidades em milímetros

TAQUILLAS MODULARES /

DISASSEMBLED LOCKERS
 VESTIAIRES DEMONTABLES
 ARMÁRIOS DE VESTIÁRIO DESMONTÁVEIS



AT-25/1
 COD. 32511

AT-25/2
 COD. 32512

AT-25/3
 COD. 32513

AT-25/4
 COD. 32514

AT-30/1
 COD. 33011

AT-30/2
 COD. 33012

AT-30/3
 COD. 33013

AT-30/4
 COD. 33014

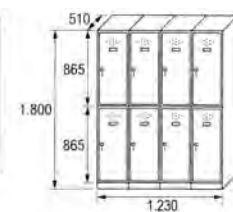
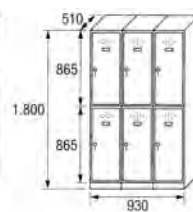
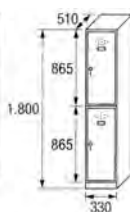
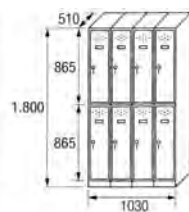
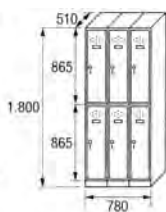
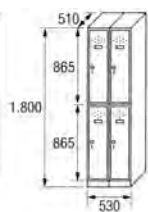
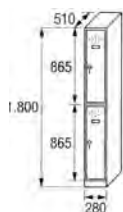

19,9 • 0,26

33,8 • 0,49

47,7 • 0,72

61,6 • 0,95

21,1 • 0,30

36,2 • 0,58

51,3 • 0,85

66,4 • 1,13

SERIE AT



AT-40

STOCK

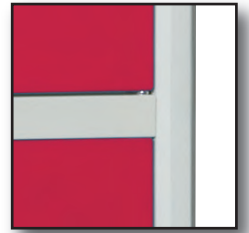

SERIE AT	↑	↔	kg	M ³	↔	kg	M ³	↗
AT-25	1800	280	19,9	0,096	250	13,9	0,077	510
AT-30	1800	330	21,1	0,096	300	15,1	0,077	510
AT-35	1800	380	22,7	0,096	350	16,7	0,077	510
AT-40	1800	430	25,0	0,096	400	19,0	0,077	510

AT-35/1
COD. 33511

AT-35/2
COD. 33512

AT-35/3
COD. 33513

AT-40/1
COD. 34011

AT-40/2
COD. 34012

AT-40/3
COD. 34013

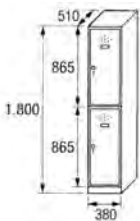

22,7 • 0,35



39,4 • 0,67

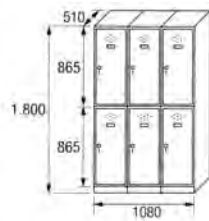

56,1 • 0,99

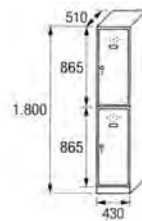

25,0 • 0,39



44,0 • 0,76

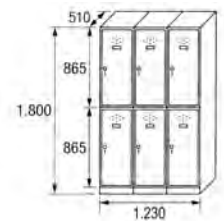

63,0 • 1,13

Unidades en milímetros / Units in milimeters / Unités en milimètres / Unidades em milímetros

TAQUILLAS MODULARES /

DISASSEMBLED LOCKERS
VESTIAIRES DEMONTABLES
ARMÁRIOS DE VESTIÁRIO DESMONTÁVEIS



AM-25/1 COD. 32531	AM-25/2 COD. 32532	AM-25/3 COD. 32533	AM-25/4 COD. 32534	AM-30/1 COD. 33031	AM-30/2 COD. 33032	AM-30/3 COD. 33033	AM-30/4 COD. 33034
20,9 • 0,26	35,8 • 0,49	50,6 • 0,72	65,5 • 0,95	22,2 • 0,30	38,4 • 0,58	54,6 • 0,85	70,8 • 1,13



SERIE AM



STOCK

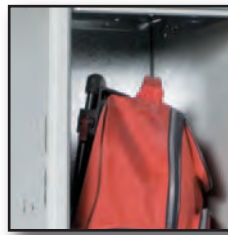

SERIE AM	↑	↔	kg	M ³	↔	kg	M ³	↗
AM-25	1800	280	20,9	0,096	250	14,9	0,077	510
AM-30	1800	330	22,2	0,096	300	16,2	0,077	510
AM-35	1800	380	23,7	0,096	350	17,7	0,077	510
AM-40	1800	430	25,2	0,096	400	19,2	0,077	510

AM-35/1
COD. 33531

AM-35/2
COD. 33532

AM-35/3
COD. 33533

AM-40/1
COD. 34031

AM-40/2
COD. 34032

AM-40/3
COD. 34033

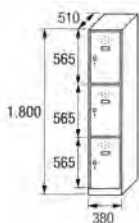

23,7 • 0,35

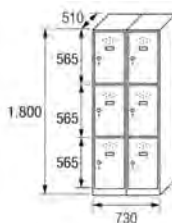

41,4 • 0,67

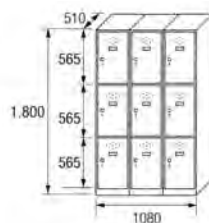

59,1 • 0,99

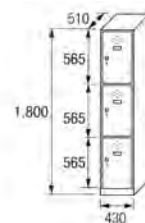

25,2 • 0,39



44,4 • 0,76

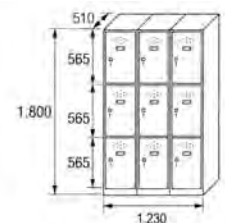

63,6 • 1,13

Unidades en milímetros / Units in milimeters / Unités en milimètres / Unidades em milímetros

TAQUILLAS MODULARES /

DISASSEMBLED LOCKERS
VESTIAIRES DEMONTABLES
ARMÁRIOS DE VESTIÁRIO DESMONTÁVEIS

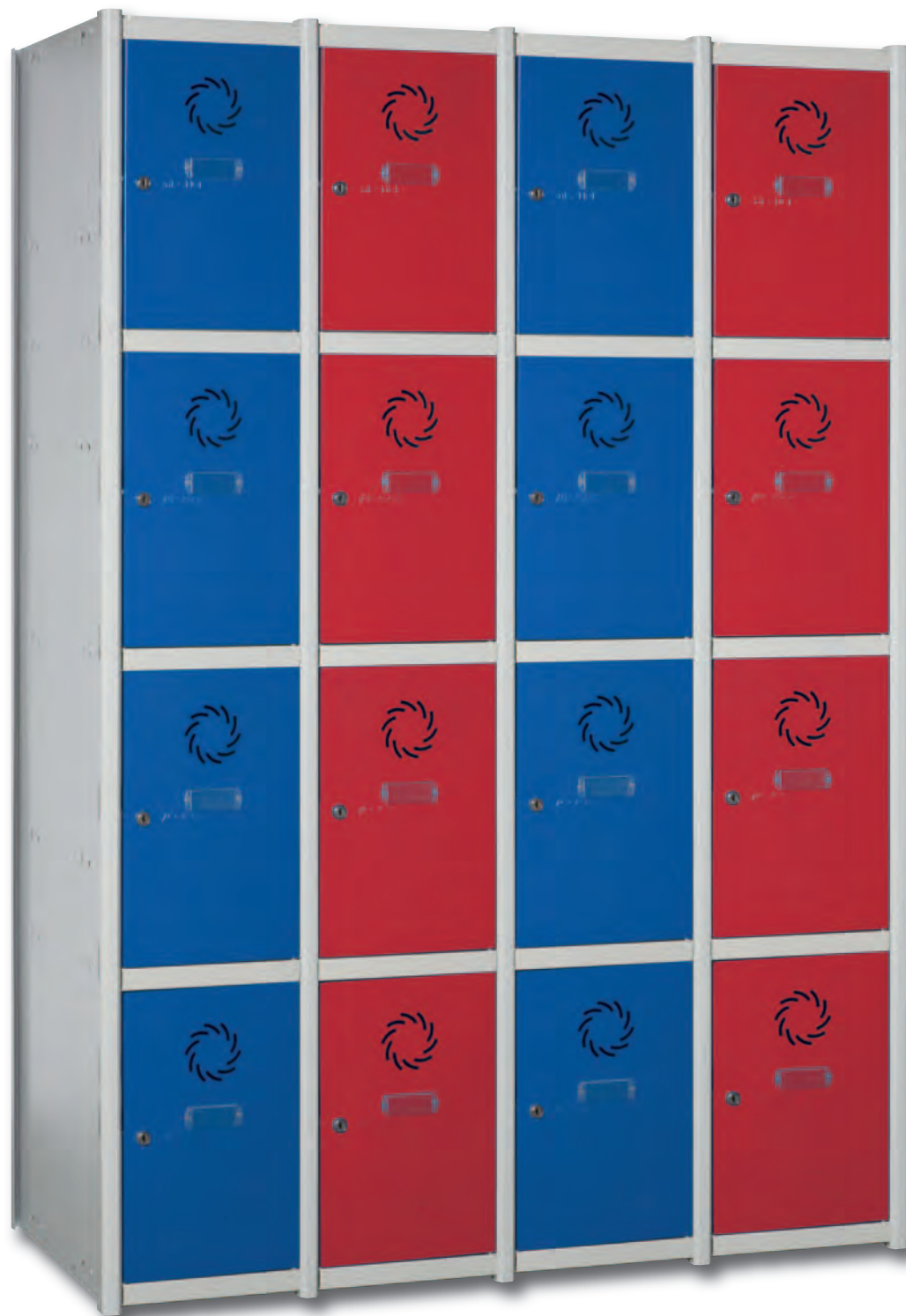

AC-25/1
COD. 32521

AC-25/2
COD. 32522

AC-25/3
COD. 32523

AC-25/4
COD. 32524

AC-30/1
COD. 33021

AC-30/2
COD. 33022

AC-30/3
COD. 33023

AC-30/4
COD. 33024

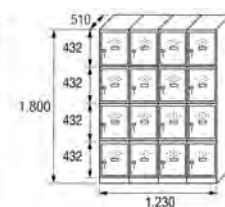
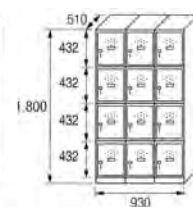
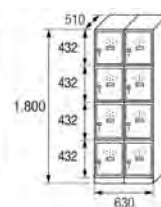
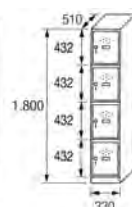
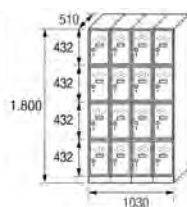
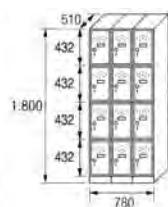
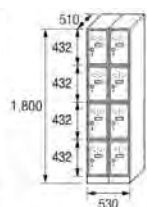
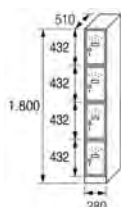

21,8 • 0,26

37,6 • 0,49

53,4 • 0,72

69,2 • 0,95

23,3 • 0,30

40,7 • 0,58

58,0 • 0,85

75,4 • 1,13

SERIE AC



STOCK



SERIE AC	↑	↔	kg	M ³	↔	kg	M ³	↗
AC-25	1800	280	21,8	0,096	250	15,8	0,077	510
AC-30	1800	330	23,3	0,096	300	17,3	0,077	510
AC-35	1800	380	25,08	0,096	350	19,08	0,077	510
AC-40	1800	430	26,7	0,096	400	20,7	0,077	510

AC-35/1
COD. 33521

AC-35/2
COD. 33522

AC-35/3
COD. 33523

AC-40/1
COD. 34021

AC-40/2
COD. 34022

AC-40/3
COD. 34023

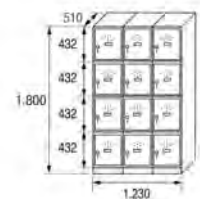
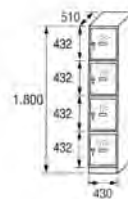
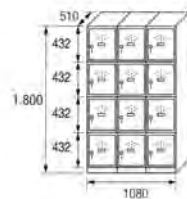
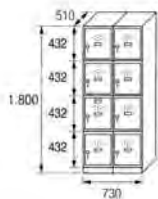
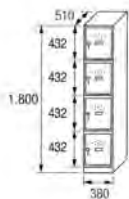

25,08 • 0,35

44,16 • 0,67

63,24 • 0,99

26,7 • 0,39

47,4 • 0,76

68,1 • 1,13

Unidades en milímetros / Units in milimeters / Unités en milimètres / Unidades em milímetros

TAQUILLAS MODULARES /

DISASSEMBLED LOCKERS
VESTIAIRES DEMONTABLES
ARMÁRIOS DE VESTIÁRIO DESMONTÁVEIS

SERIE AP



SERIE AB



SERIE AZ



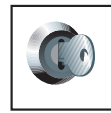
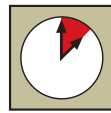

STOCK

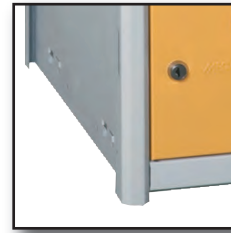

SERIES	COD.	↑	↔	↗	↓	kg	M ³
AP-25-1	32551	1800	280	510	351	22,7	0,26
AP-25-2	32552	1800	530	510	351	39,4	0,49
AP-25-3	32553	1800	780	510	351	56,1	0,72
AP-25-4	32554	1800	1030	510	351	72,8	0,95
AP-30-1	33051	1800	330	510	351	24,4	0,30
AP-30-2	33052	1800	630	510	351	42,9	0,58
AP-30-3	33053	1800	930	510	351	61,3	0,85
AP-30-4	33054	1800	1230	510	351	79,8	1,13
AP-40-1	34051	1800	430	510	351	28,1	0,39
AP-40-2	34052	1800	830	510	351	50,2	0,76
AP-40-3	34053	1800	1230	510	351	72,3	1,13
AB-25-1	32561	1800	280	510	292	23,6	0,26
AB-25-2	32562	1800	530	510	292	41,2	0,49
AB-25-3	32563	1800	780	510	292	58,8	0,72
AB-25-4	32564	1800	1030	510	292	76,4	0,95
AB-30-1	33061	1800	330	510	292	25,5	0,30
AB-30-2	33062	1800	630	510	292	45,1	0,58
AB-30-3	33063	1800	930	510	292	64,6	0,85
AB-30-4	33064	1800	1230	510	292	84,2	1,13
AB-40-1	34061	1800	430	510	292	29,1	0,39
AB-40-2	34062	1800	830	510	292	51,2	0,76
AB-40-3	34063	1800	1230	510	292	73,3	1,13
AZ-25-1	32581	1800	280	510	219	25,4	0,26
AZ-25-2	32582	1800	530	510	219	44,8	0,49
AZ-25-3	32583	1800	780	510	219	64,2	0,72
AZ-25-4	32584	1800	1030	510	219	83,6	0,95
AZ-30-1	33081	1800	330	510	219	27,7	0,30
AZ-30-2	33082	1800	630	510	219	49,5	0,58
AZ-30-3	33083	1800	930	510	219	71,2	0,85
AZ-30-4	33084	1800	1230	510	219	93,0	1,13
AZ-40-1	34081	1800	430	510	219	31,9	0,39
AZ-40-2	34082	1800	830	510	219	56,8	0,76
AZ-40-3	34083	1800	1230	510	219	81,7	1,13

Unidades en milímetros / Units in millimeters / Unités en millimètres / Unidades em milímetros

TAQUILLAS MODULARES /

DISASSEMBLED LOCKERS
VESTIAIRES DEMONTABLES
ARMÁRIOS DE VESTIÁRIO DESMONTÁVEIS



STOCK

SERIE GYM

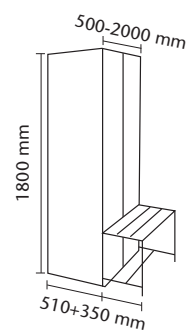

TAQUILLAS MODULARES /

DISASSEMBLED LOCKERS
VESTIAIRES DEMONTABLES
ARMÁRIOS DE VESTIÁRIO DESMONTÁVEIS

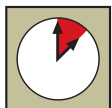

STOCK

SERIE CHASIS

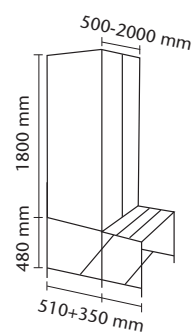
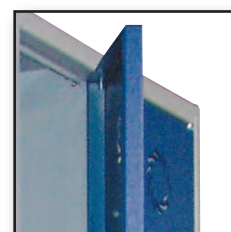

TAQUILLAS LUX /

LUX LOCKERS
VESTIAIRES LUX
ARMÁRIOS DE VESTIÁRIO LUX

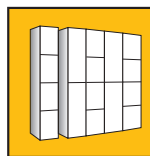

**MICRO
TEXT**



OPCIONES / OPTIONS / OPTIONS / OPÇÕES



Sin tirador
No handle
Sans tireur
Sem tirador



Ver pág. 9 / See page 9 / Voir Page 9 / Ver pág. 9



ME
TAL

E
PO
XI

CUERPO/BODY/
CORPS/CORPO
RAL 7035
PUERTA/DOOR/
PORTE/PORTA
RAL 5010



NOVEDAD
EW / NOUVEAU /
NOVEDADE

NOVEDAD
EW / NOUVEAU /
NOVEDADE

NOVEDAD
EW / NOUVEAU /
NOVEDADE

STOCK



COLORES OPCIONALES / OPTIONAL COLOURS / COULEURS EN OPTION / CORES OPCIONAIS

RAL 9010

RAL 6029

RAL 1021

RAL 1017

RAL 3000

RAL 3005

RAL 6034

RAL 5015

RAL 5023

RAL 2004

RAL 7016

RAL 7036

RAL 9006

RAL 9005



TAQUILLAS LUX /

LUX LOCKERS
VESTIAIRES LUX
ARMÁRIOS DE VESTIÁRIO LUX



LV-25/1
COD. 72501

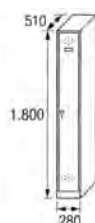

LV-25/2
COD. 72505

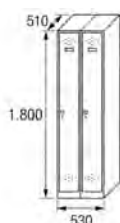

LV-25/3
COD. 72503

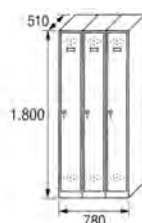

LV-25/4
COD. 72504



LV-30/1
COD. 73001



LV-30/2
COD. 73002

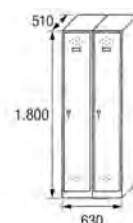

kg • M³ 19,2 • 0,26

32,4 • 0,49

45,5 • 0,72

58,7 • 0,95

21,5 • 0,30

37,0 • 0,58

SERIE LV

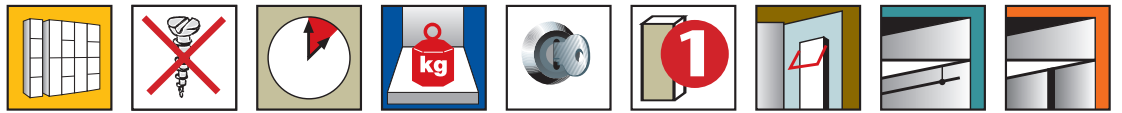

LV-40

STOCK



SERIE LV	↑	↔	kg	M ³	↔	kg	M ³	↗
LV-25	1800	280	19,2	0,096	250	13,2	0,077	510
LV-30	1800	330	21,5	0,096	300	15,5	0,077	510
LV-40	1800	430	26,5	0,096	400	20,5	0,077	510

LV-30/3
COD. 73003



52,5 • 0,85

LV-30/4
COD. 73004



68,0 • 1,13

LV-40/1
COD. 74001

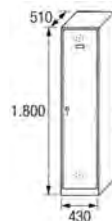

26,5 • 0,39

LV-40/2
COD. 74002

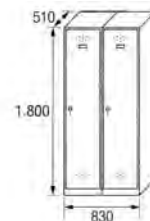

47,0 • 0,76

LV-40/3
COD. 74003



67,5 • 1,13

Unidades en milímetros / Units in milimeters / Unités en milimètres / Unidades em milímetros

TAQUILLAS LUX / LUX LOCKERS

VESTIAIRES LUX
ARMÁRIOS DE VESTIÁRIO LUX



LT-25/1
COD. 72511

LT-25/2
COD. 72512

LT-25/3
COD. 72513

LT-25/4
COD. 72514

LT-30/1
COD. 73011

LT-30/2
COD. 73012

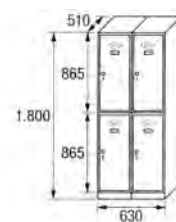
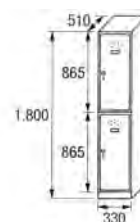
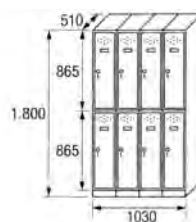
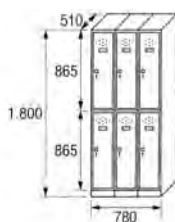
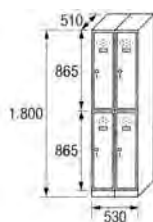
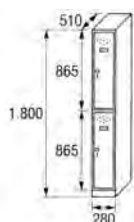

19,9 • 0,26

33,8 • 0,49

47,7 • 0,72

61,6 • 0,95

21,1 • 0,30

36,2 • 0,58

SERIE LT



STOCK

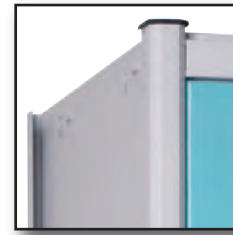

SERIE LT	↑	↔	kg	M ³	↔	kg	M ³	↗
LT-25	1800	280	19,9	0,096	250	13,9	0,077	510
LT-30	1800	330	21,1	0,096	300	15,1	0,077	510
LT-40	1800	430	25,0	0,096	400	19,0	0,077	510

LT-30/3
COD. 73013

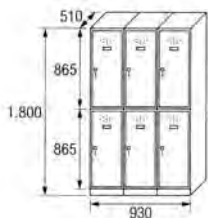

51,3 • 0,85

LT-30/4
COD. 73014

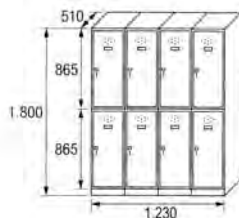

66,4 • 1,13

LT-40/1
COD. 74011

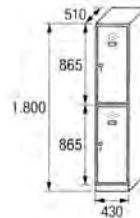

25,0 • 0,39

LT-40/2
COD. 74012



44,0 • 0,76

LT-40/3
COD. 74013

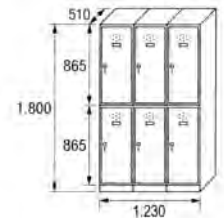

63,0 • 1,13

Unidades en milímetros / Units in milimeters / Unités en milimètres / Unidades em milímetros

TAQUILLAS LUX /

LUX LOCKERS
VESTIAIRES LUX
ARMÁRIOS DE VESTIÁRIO LUX



LM-25/1
COD. 72531

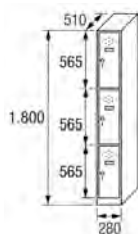

20,9 • 0,26

LM-25/2
COD. 72532

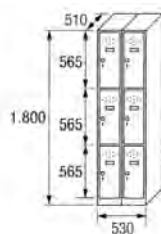

35,8 • 0,49

LM-25/3
COD. 72533

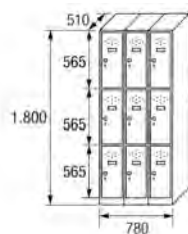

50,6 • 0,72

LM-25/4
COD. 72534

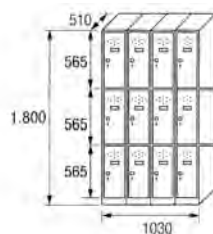

65,5 • 0,95

LM-30/1
COD. 73031

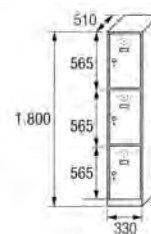

22,2 • 0,30

LM-30/2
COD. 73032

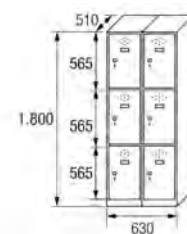

38,4 • 0,58



SERIE LM

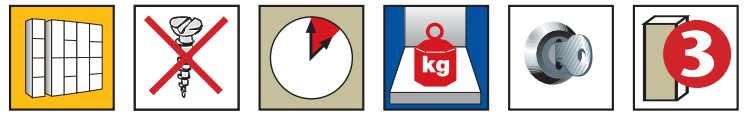

STOCK

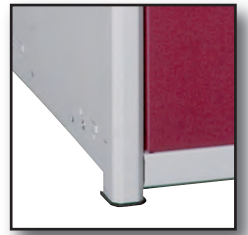

SERIE LM	↑	↔	kg	M ³	↔	kg	M ³	↗
LM-25	1800	280	20,9	0,096	250	14,9	0,077	510
LM-30	1800	330	22,2	0,096	300	16,2	0,077	510
LM-40	1800	430	25,2	0,096	400	19,2	0,077	510

LM-30/3
COD. 73033

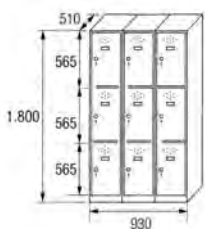

54,6 • 0,85

LM-30/4
COD. 73034

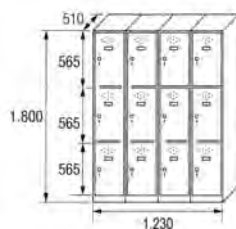

70,8 • 1,13

LM-40/1
COD. 74031

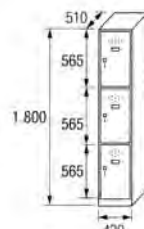

25,2 • 0,39

LM-40/2
COD. 74032

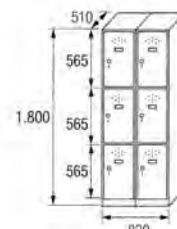

44,4 • 0,76

LM-40/3
COD. 74033

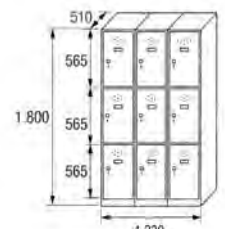

63,6 • 1,13

Unidades en milímetros / Units in milimeters / Unités en milimètres / Unidades em milímetros

TAQUILLAS LUX /

LUX LOCKERS
VESTIAIRES LUX
ARMÁRIOS DE VESTIÁRIO LUX



LC-25/1
COD. 72521

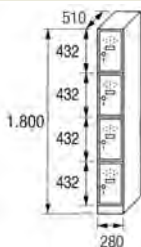

21,8 • 0,26

LC-25/2
COD. 72522

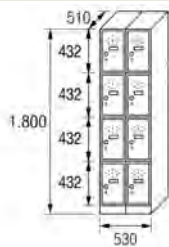

37,6 • 0,49

LC-25/3
COD. 72523

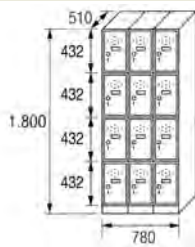

53,4 • 0,72

LC-25/4
COD. 72524

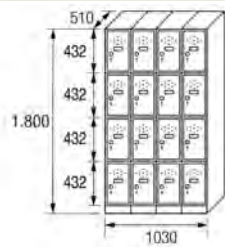

69,2 • 0,95

LC-30/1
COD. 73021

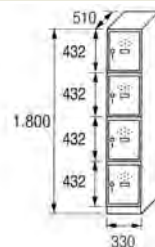

23,3 • 0,30

LC-30/2
COD. 73022

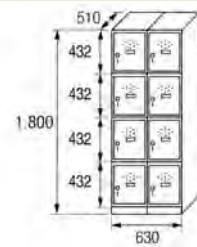

40,7 • 0,58



SERIE LC



STOCK



SERIE LC	↑	↔	kg	M ³	↔	kg	M ³	↗
LC-25	1800	280	21,8	0,096	250	15,8	0,077	510
LC-30	1800	330	23,3	0,096	300	17,3	0,077	510
LC-40	1800	430	26,7	0,096	400	20,7	0,077	510

LC-30/3
COD. 73023

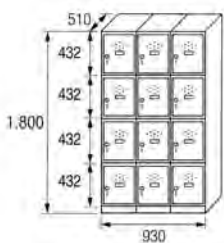

58,0 • 0,85

LC-30/4
COD. 73024

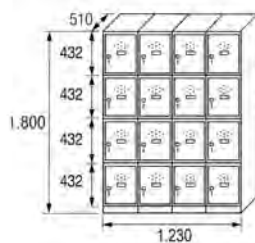

75,4 • 1,13

LC-40/1
COD. 74021

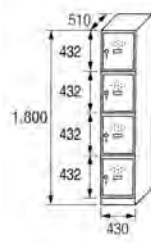

26,7 • 0,39

LC-40/2
COD. 74022

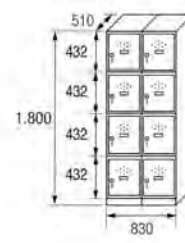

47,4 • 0,76

LC-40/3
COD. 74023

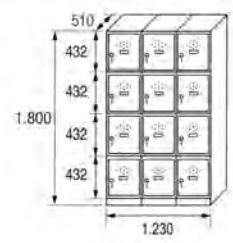

68,1 • 1,13

Unidades en milímetros / Units in milimeters / Unités en milimètres / Unidades em milímetros

TAQUILLAS LUX /

LUX LOCKERS
VESTIAIRES LUX
ARMÁRIOS DE VESTIÁRIO LUX

SERIE LP



SERIE LB



SERIE LZ



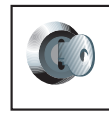
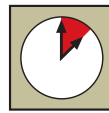

STOCK



SERIES	COD.	↑	↔	↗	↓	kg	M ^s
LP-25-1	72551	1800	280	510	351	22,7	0,26
LP-25-2	72552	1800	530	510	351	39,4	0,49
LP-25-3	72553	1800	780	510	351	56,1	0,72
LP-25-4	72554	1800	1030	510	351	72,8	0,95
LP-30-1	73051	1800	330	510	351	24,4	0,30
LP-30-2	73052	1800	630	510	351	42,9	0,58
LP-30-3	73053	1800	930	510	351	61,3	0,85
LP-30-4	73054	1800	1230	510	351	79,8	1,13
LP-40-1	74051	1800	430	510	351	28,1	0,39
LP-40-2	74052	1800	830	510	351	50,2	0,76
LP-40-3	74053	1800	1230	510	351	72,3	1,13
LB-25-1	72561	1800	280	510	292	23,6	0,26
LB-25-2	72562	1800	530	510	292	41,2	0,49
LB-25-3	72563	1800	780	510	292	58,8	0,72
LB-25-4	72564	1800	1030	510	292	76,4	0,95
LB-30-1	73061	1800	330	510	292	25,5	0,30
LB-30-2	73062	1800	630	510	292	45,1	0,58
LB-30-3	73063	1800	930	510	292	64,6	0,85
LB-30-4	73064	1800	1230	510	292	84,2	1,13
LB-40-1	74061	1800	430	510	292	29,1	0,39
LB-40-2	74062	1800	830	510	292	51,2	0,76
LB-40-3	74063	1800	1230	510	292	73,3	1,13
LZ-25-1	72581	1800	280	510	219	25,4	0,26
LZ-25-2	72582	1800	530	510	219	44,8	0,49
LZ-25-3	72583	1800	780	510	219	64,2	0,72
LZ-25-4	72584	1800	1030	510	219	83,6	0,95
LZ-30-1	73081	1800	330	510	219	27,7	0,30
LZ-30-2	73082	1800	630	510	219	49,5	0,58
LZ-30-3	73083	1800	930	510	219	71,2	0,85
LZ-30-4	73084	1800	1230	510	219	93,0	1,13
LZ-40-1	74081	1800	430	510	219	31,9	0,39
LZ-40-2	74082	1800	830	510	219	56,8	0,76
LZ-40-3	74083	1800	1230	510	219	81,7	1,13

Unidades en milímetros / Units in milimeters / Unités en milimètres / Unidades em milímetros

TAQUILLAS MONOBLOK

MONOBLOC LOCKERS
VESTIAIRES MONOBLOC
CACIFOS MONOBLOK

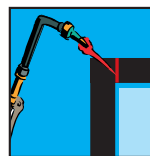

**MICRO
TEXT**



OPCIONES / OPTIONS / OPTIONS / OPÇÕES

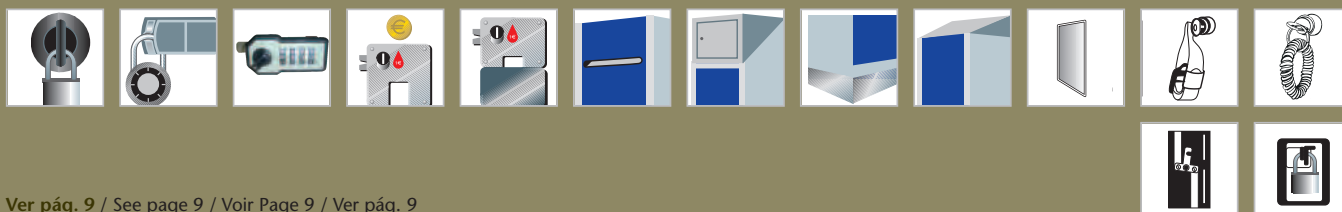

Ver pág. 9 / See page 9 / Voir Page 9 / Ver pág. 9



ME
TAL

E
PO
XI

CUERPO/BODY
CORPS/CORPS
RAL 7035
PUERTA/DOOR/
PORTE/PORTE
RAL 5010

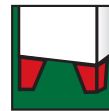
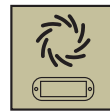

NOVEDAD
EW / NOUVEAU /
NOVEDADE

NOVEDAD
EW / NOUVEAU /
NOVEDADE

NOVEDAD
EW / NOUVEAU /
NOVEDADE



COLORES OPCIONALES / OPTIONAL COLOURS / COULEURS EN OPTION / CORES OPCIONAIS

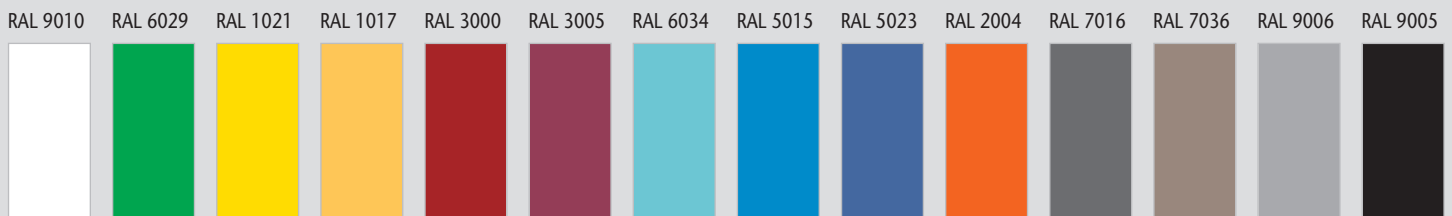

TAQUILLAS MONOBLOK /

MONOBLOC LOCKERS
VESTIAIRES MONOBLOC
CACIFOS MONOBLOK



SV-25/1
COD. 42501

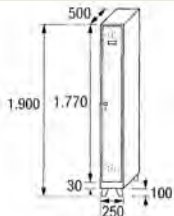

18,5 • 0,24

SV-25/2
COD. 42502

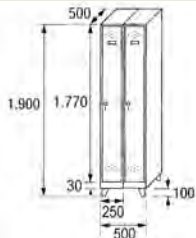

31,0 • 0,48

SV-25/3
COD. 42503

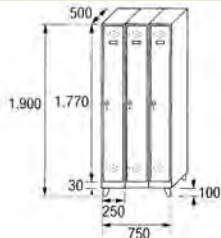

44,5 • 0,71

SV-25/4
COD. 42504

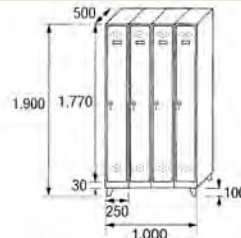

57,0 • 0,95

SV-30/1
COD. 43001

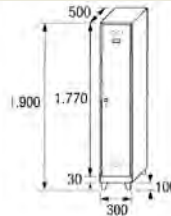

20,6 • 0,29

SV-30/2
COD. 43002

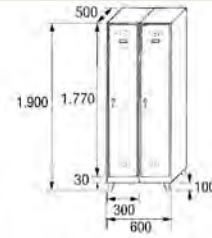

35,2 • 0,57



SERIE SV

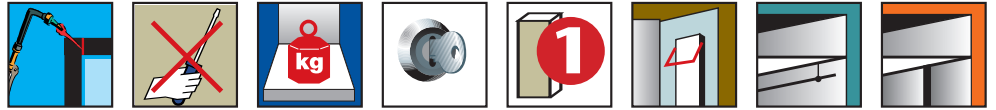

SV-40 / SV-50



Mod. SV-40 / Mod. SV-50

SV-30/3
COD. 43003

SV-30/4
COD. 43004

SV-40/1
COD. 44001

SV-40/2
COD. 44002

SV-40/3
COD. 44003

SV-50/1
COD. 45001

SV-50/2
COD. 45002

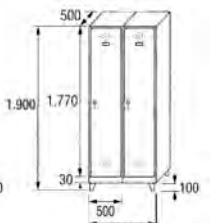
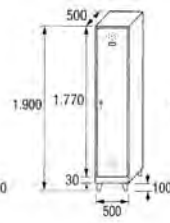
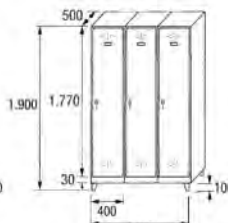
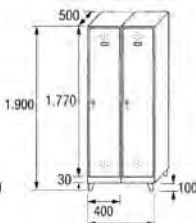
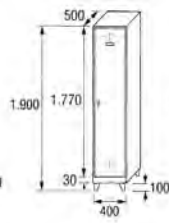
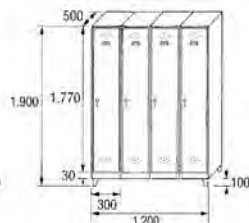
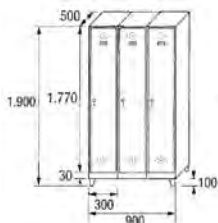

49,8 • 0,86

64,4 • 1,14

25,0 • 0,38

45,0 • 0,76

65,0 • 1,14

28,0 • 0,48

51,0 • 0,95

Unidades en milímetros / Units in milimeters / Unités en milimètres / Unidades em milímetros

TAQUILLAS MONOBLOK /

MONOBLOC LOCKERS
VESTIAIRES MONOBLOC
CACIFOS MONOBLOK

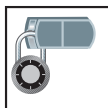

ST-25/1
COD. 42511

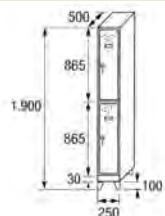

ST-25/2
COD. 42512

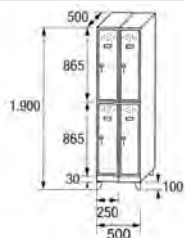

ST-25/3
COD. 42513

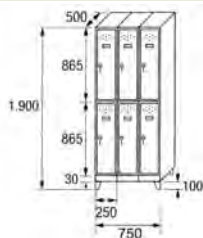

ST-25/4
COD. 42514

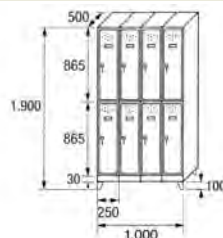

ST-30/1
COD. 43011

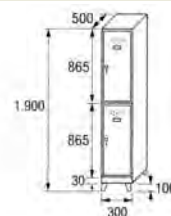

ST-30/2
COD. 43012

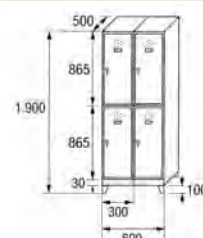

18,4 • 0,24

30,8 • 0,48

44,2 • 0,71

56,6 • 0,95

19,8 • 0,29

33,6 • 0,57

SERIE ST

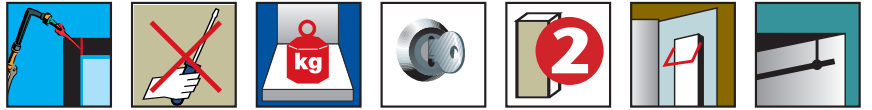

ST-40 / ST-50

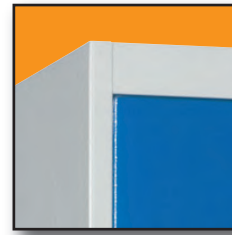

ST-30/3
COD. 43013

ST-30/4
COD. 43014

ST-40/1
COD. 44011

ST-40/2
COD. 44012

ST-40/3
COD. 44013

ST-50/1
COD. 45011

ST-50/2
COD. 45012

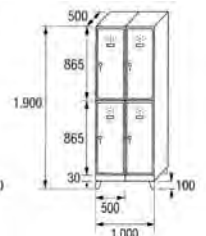
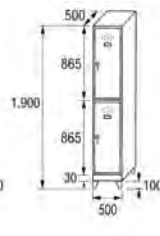
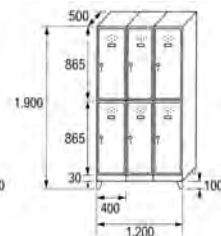
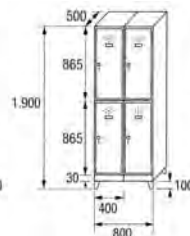
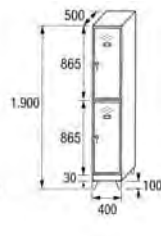
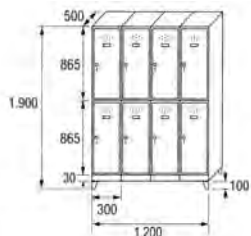
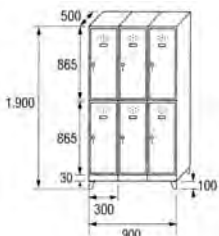

47,4 • 0,86

62,2 • 1,14

23,0 • 0,38

41,0 • 0,76

59,0 • 1,14

26,0 • 0,48

47,0 • 0,95

Unidades en milímetros / Units in milimeters / Unités en milimètres / Unidades em milímetros

TAQUILLAS MONOBLOK /

MONOBLOC LOCKERS
VESTIAIRES MONOBLOC
CACIFOS MONOBLOK



SM-25/1
COD. 42531

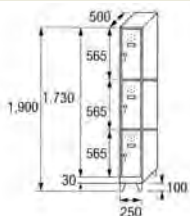

19,6 • 0,24

SM-25/2
COD. 42532

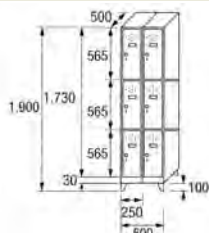

33,2 • 0,48

SM-25/3
COD. 42533

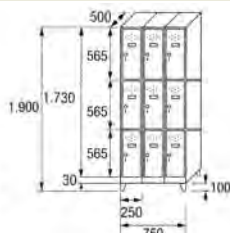

46,7 • 0,71

SM-25/4
COD. 42534

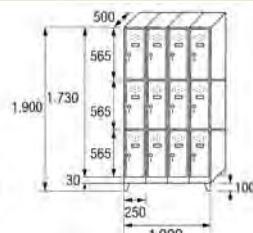

60,3 • 0,95

SM-30/1
COD. 43031

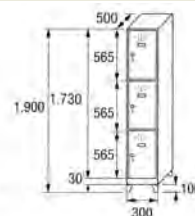

21,0 • 0,29

SM-30/2
COD. 43032

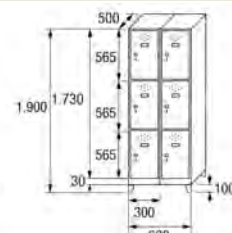

36,0 • 0,57



SERIE SM

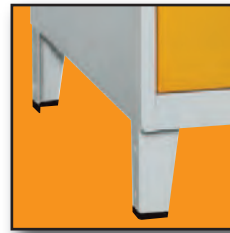
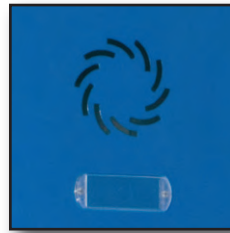
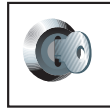
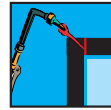

SM-30/3
COD. 43033

SM-30/4
COD. 43034

SM-40/1
COD. 44031

SM-40/2
COD. 44032

SM-40/3
COD. 44033

SM-50/1
COD. 45031

SM-50/2
COD. 45032

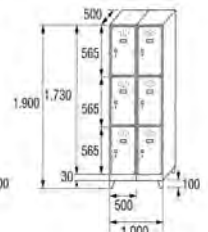
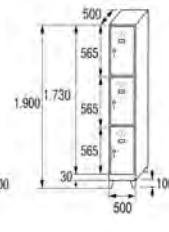
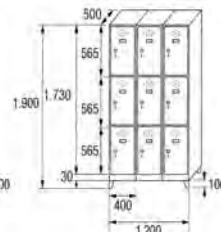
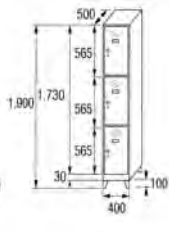
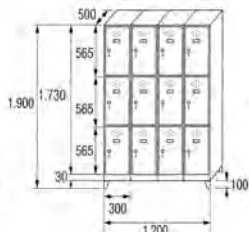
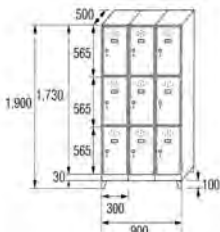

51,0 • 0,86

66,0 • 1,14

23,9 • 0,38

41,8 • 0,76

59,7 • 1,14

25,8 • 0,48

46,6 • 0,95

Unidades en milímetros / Units in milimeters / Unités en milimètres / Unidades em milímetros

TAQUILLAS MONOBLOK /

MONOBLOC LOCKERS
VESTIAIRES MONOBLOC
CACIFOS MONOBLOK

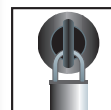

SC-25/1
COD. 42521

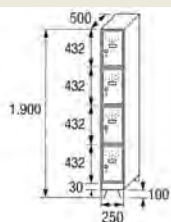

SC-25/2
COD. 42522

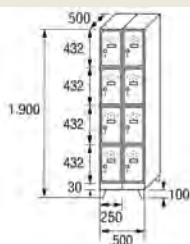

SC-25/3
COD. 42523

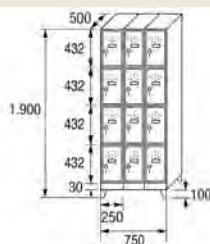

SC-25/4
COD. 42524

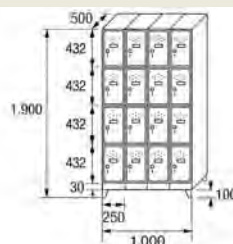

SC-30/1
COD. 43021

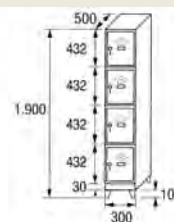

SC-30/2
COD. 43022

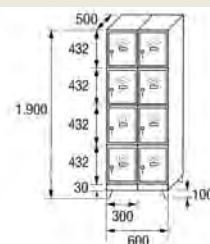

19,6 • 0,24

34,2 • 0,48

48,8 • 0,71

63,4 • 0,95

21,0 • 0,29

37,1 • 0,57

SERIE SC

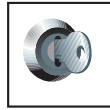
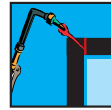

SC-30/3
COD. 43023

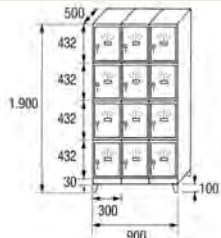

53,1 • 0,86

SC-30/4
COD. 43024

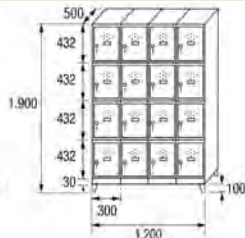

69,2 • 1,14

SC-40/1
COD. 44021

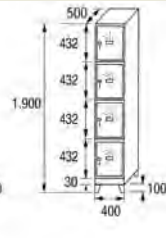

25,0 • 0,38

SC-40/2
COD. 44022

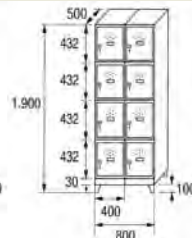

44,0 • 0,76

SC-40/3
COD. 44023

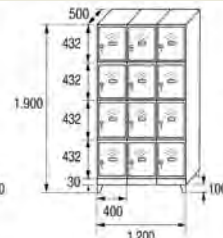

63,0 • 1,14

SC-50/1
COD. 45021

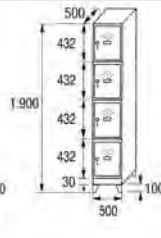

27,8 • 0,48

SC-50/2
COD. 45022

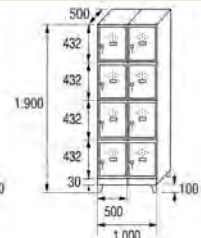

49,6 • 0,95

Unidades en milímetros / Units in milimeters / Unités en milimètres / Unidades em milímetros

TAQUILLAS MONOBLOK / MONOBLOC LOCKERS VESTIAIRES MONOBLOC CACIFOS MONOBLOK

SERIE SP



SERIE SB



SERIE SZ



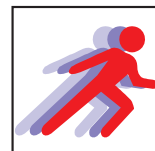
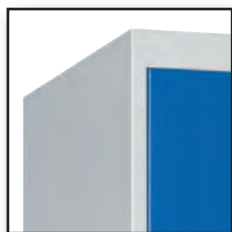
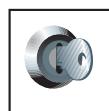
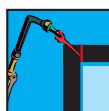

SERIES	COD.	↑	↔	↗	↓	kg	M ³
SP-25-1	42551	1900	250	500	351	20,6	0,24
SP-25-2	42552	1900	500	500	351	36,2	0,48
SP-25-3	42553	1900	750	500	351	51,8	0,71
SP-25-4	42554	1900	1000	500	351	67,4	0,95
SP-30-1	43051	1900	300	500	351	22,0	0,29
SP-30-2	43052	1900	600	500	351	39,1	0,57
SP-30-3	43053	1900	900	500	351	56,1	0,86
SP-30-4	43054	1900	1200	500	351	73,2	1,14
SP-40-1	44051	1900	400	500	351	26,0	0,38
SP-40-2	44052	1900	800	500	351	46,0	0,76
SP-40-3	44053	1900	1200	500	351	66,0	1,14
SP-50-1	45051	1900	500	500	351	28,8	0,48
SP-50-2	45052	1900	1000	500	351	51,6	0,95
SB-25-1	42561	1900	250	500	292	21,6	0,24
SB-25-2	42562	1900	500	500	292	38,2	0,48
SB-25-3	42563	1900	750	500	292	54,8	0,71
SB-25-4	42564	1900	1000	500	292	71,4	0,95
SB-30-1	43061	1900	300	500	292	23,0	0,29
SB-30-2	43062	1900	600	500	292	41,1	0,57
SB-30-3	43063	1900	900	500	292	59,1	0,86
SB-30-4	43064	1900	1200	500	292	72,2	1,14
SB-40-1	44061	1900	400	500	292	27,0	0,38
SB-40-2	44062	1900	800	500	292	48,0	0,76
SB-40-3	44063	1900	1200	500	292	69,0	1,14
SB-50-1	45061	1900	500	500	292	29,8	0,48
SB-50-2	45062	1900	1000	500	292	53,6	0,95
SZ-25-1	42581	1900	250	500	219	23,6	0,24
SZ-25-2	42582	1900	500	500	219	42,2	0,48
SZ-25-3	42583	1900	750	500	219	60,8	0,71
SZ-25-4	42584	1900	1000	500	219	79,4	0,95
SZ-30-1	43081	1900	300	500	219	25,0	0,29
SZ-30-2	43082	1900	600	500	219	45,1	0,57
SZ-30-3	43083	1900	900	500	219	65,1	0,86
SZ-30-4	43084	1900	1200	500	219	85,2	1,14
SZ-40-1	44081	1900	400	500	219	29,0	0,38
SZ-40-2	44082	1900	800	500	219	52,0	0,76
SZ-40-3	44083	1900	1200	500	219	75,0	1,14
SZ-50-1	45081	1900	500	500	219	31,8	0,48
SZ-50-2	45082	1900	1000	500	219	57,6	0,95

Unidades en milímetros / Units in milimeters / Unités en milimètres / Unidades em milímetros

TAQUILLAS MONOBLOK

MONOBLOC LOCKERS
VESTIAIRES MONOBLOC
CACIFOS MONOBLOK

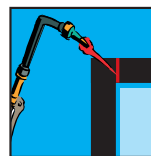

**MICRO
TEXT**

NOVEDAD
EW / NOUVEAU /
NOVEDADE

NOVEDAD
EW / NOUVEAU /
NOVEDADE



OPCIONES / OPTIONS / OPTIONS / OPÇÕES

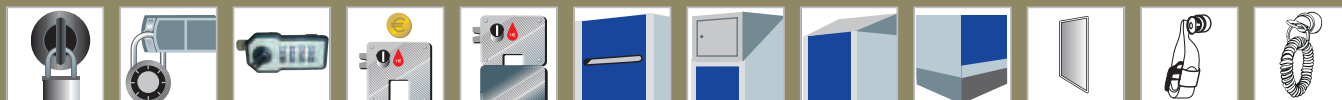

SL

Ver pág. 9 / See page 9 / Voir Page 9 / Ver pág. 9

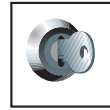
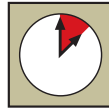

NOVEDAD
EW / NOUVEAU /
NOVEDADE

NOVEDAD
EW / NOUVEAU /
NOVEDADE

NOVEDAD
EW / NOUVEAU /
NOVEDADE

NOVEDAD
EW / NOUVEAU /
NOVEDADE



COLORES OPCIONALES / OPTIONAL COLOURS / COULEURS EN OPTION / CORES OPCIONAIS

RAL 9010	RAL 6029	RAL 1021	RAL 1017	RAL 3000	RAL 3005	RAL 6034	RAL 5015	RAL 5023	RAL 2004	RAL 7016	RAL 7036	RAL 9006	RAL 9005

TAQUILLAS MONOBLOK /

MONOBLOC LOCKERS
VESTIAIRES MONOBLOC
CACIFOS MONOBLOK

NUEVAS MEDIDAS
NEW SIZES
NOUVELLES MESURES
NOVAS MEDIDAS



SL2-30/1
COD. 43041

SL2-30/2
COD. 43042

SL2-30/3
COD. 43043

SL2-40/1
COD. 44041

SL2-40/2
COD. 44042

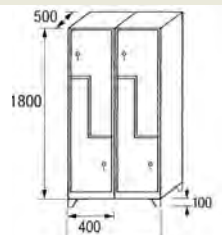
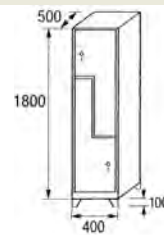
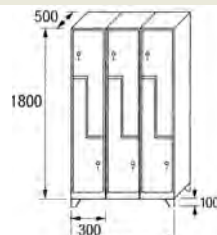
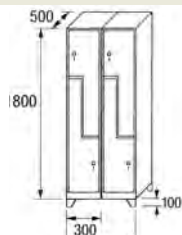
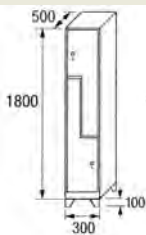

21,0 • 0,29

37,1 • 0,57

53,1 • 0,86

25,0 • 0,38

44,0 • 0,76

SERIE SL

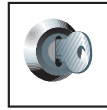
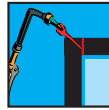

SL4-30/1
COD. 43051

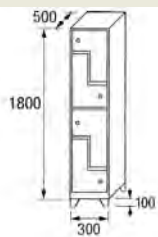

21,0 • 0,29

SL4-30/2
COD. 43052

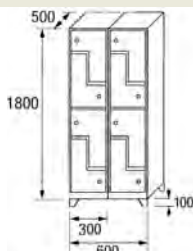

37,1 • 0,57

SL4-30/3
COD. 43053

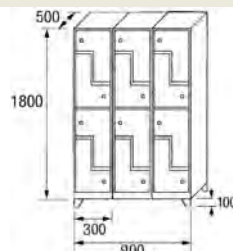

53,1 • 0,86

SL4-40/1
COD. 44051

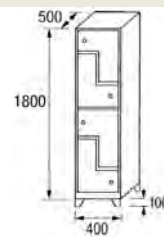

25,0 • 0,38

SL4-40/2
COD. 44052

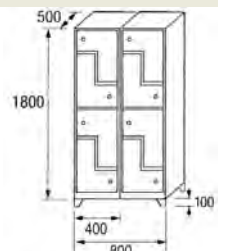

44,0 • 0,76

Unidades en milímetros / Units in milimeters / Unités en milimètres / Unidades em milímetros

TAQUILLAS MULTIPUERTAS

MULTIDOOR LOCKER
CASIERS VISITABLES
CACIFO MULTIPORTAS

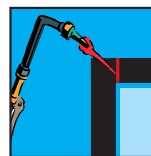

**MICRO
TEXT**



STV2-40/1
COD. 44021

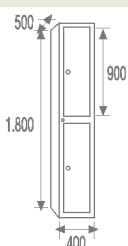

25,0 • 0,29

STV2-40/2
COD. 44022

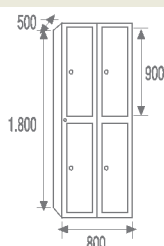

45,0 • 0,57

STV3-40/1
COD. 44031

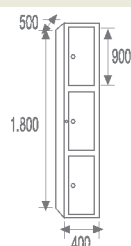

25,9 • 0,29

STV3-40/2
COD. 44032

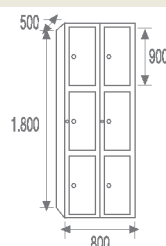

45,8 • 0,57

STV4-40/1
COD. 44041

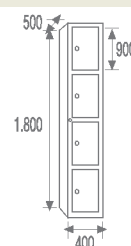

27,0 • 0,29

STV4-40/2
COD. 44042

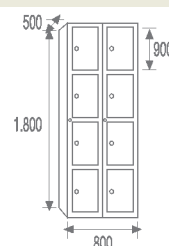

48,0 • 0,57



SERIE STV

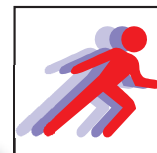
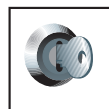

STV5-40/1
COD. 44051

STV5-40/2
COD. 44052

STV6-40/1
COD. 44061

STV6-40/2
COD. 44062

STV8-40/1
COD. 44081

STV8-40/2
COD. 44082

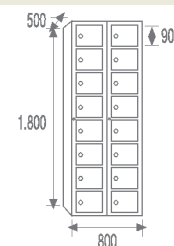
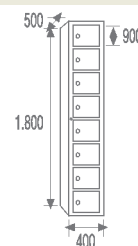
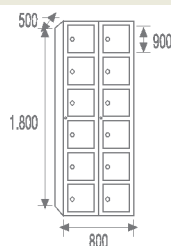
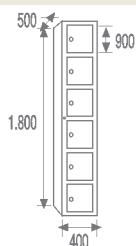
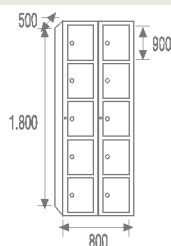
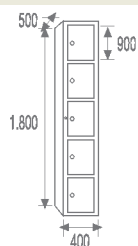

28,0 • 0,29

50,0 • 0,57

29,0 • 0,29

52,0 • 0,57

31,0 • 0,29

56,0 • 0,57

Unidades en milímetros / Units in milimeters / Unités en milimètres / Unidades em milímetros

TAQUILLAS ESPECIALES /

ESPECIAL LOCKERS
VESTIAIRES SPECIALISES
CACIFOS ESPECIALES



TAQUILLA CON GUARDARROPA /

WARDROBE LOCKER
VESTIAIRES PENDERIES DE BUREAU
CACIFO COM GUARDA-ROUPA

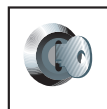
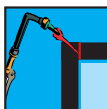

**PARA VESTUARIOS
CON POCO ESPACIO**
FOR CHANGING ROOM WITH LITTLE SPACE
POUR LES LIEUX AVEC PEU D'ESPACE
PARA VESTIÁRIOS COM POUÇO ESPAÇO

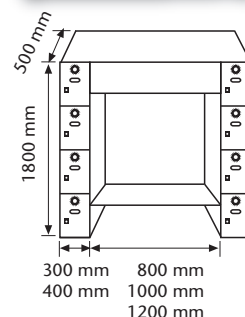

TAQUILLAS ESPECIALES /

ESPECIAL LOCKERS
VESTIAIRES SPECIALISES
CACIFOS ESPECIALES



TAQUILLA LAVANDERÍA

LAUNDRY BULK COLLECTOR LOCKER
ARMOIRE A LINGE
CACIFO LAVANDERIA

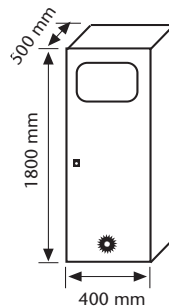
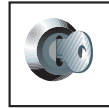
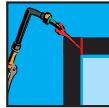

MOD. TL-I
COD. 42100

El trabajador deposita en esta taquilla la ropa sucia.
The worker deposits soiled clothing into the locker.
Le personnel dépose dans cette armoire le linge sale.
O trabalhador deixa dentro do cacifo a roupa suja.

TAQUILLAS ESPECIALES /

ESPECIAL LOCKERS
VESTIAIRES SPECIALISES
CACIFOS ESPECIALES



TAQUILLAS SKI /

SKY LOCKER
VESTIAIRES À SKI
CACIFOS SKI

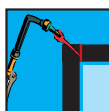

MOD. SKI-2
COD. 42530

MOD. SKI-1
COD. 42500



SERIES	↑	↔	kg	M ³
SKI-1	2200	500	44,0	0,55
SKI-2	2200	300	31,0	0,33

TAQUILLAS ESPECIALES /

ESPECIAL LOCKERS
VESTIAIRES SPECIALISES
CACIFOS ESPECIALES

TAQUILLAS SKI /

SKY LOCKER
VESTIAIRES À SKI
CACIFOS SKI

NOVEDAD
NEW / NOUVEAU /
NOVEDADE

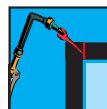

**ME
TAL**

**E
PO
XI**



MOD. SB-2P
COD. 10800



Opción calefactable
Option calefactable
Option chauffante
Opção calentador



MOD. PSV-1C
COD. 10950



MOD. PS-1
COD. 10901



MOD. PS-1C
COD. 10910



MOD. PS-3P
COD. 10903



MOD. PS-2P
COD. 10902

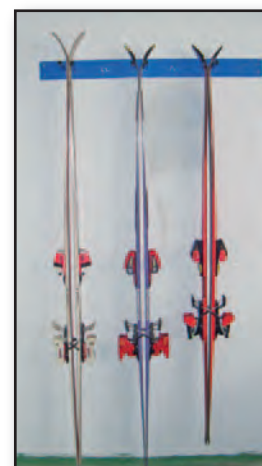

MOD. PS-3PC
COD. 10930

TAQUILLAS ESPECIALES /

ESPECIAL LOCKERS
VESTIAIRES SPECIALISES
CACIFOS ESPECIALES

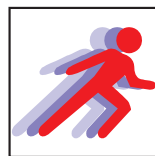

ARMARIO MATERIAL DE LIMPIEZA /

CLEANING MATERIAL LOCKER
ARMOIRE POUR MATERIEL DE NETTOYAGE
ARMARIO DE LIMPIEZA

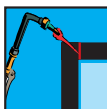

**TODO LIMPIO
Y ORDENADO**
ALL CLEAN AND TIDY
TOUT PROPE ET RANGE
TUDO LIMPO E ORGANIZADO

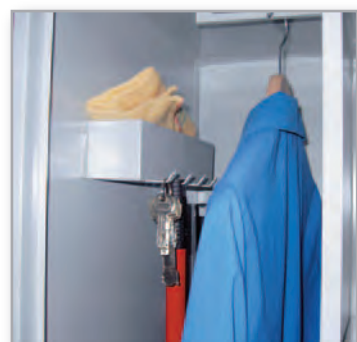

MOD. AL-I
COD. 42000

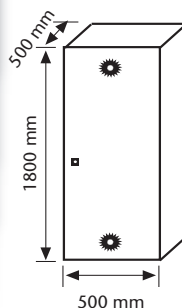

ARMARIO DE OFICINA Y TALLER

OFFICE AND INDUSTRIAL CUPBOARDS
 ARMOIRES DE BUREAU ET ATELIER
 ARMÁRIOS DE ESCRITORIO

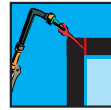

STANDARD
 RAL 7035



MOD. ARM05
 COD. 90001

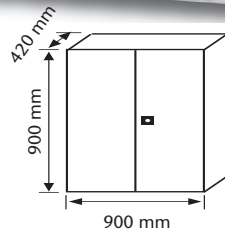

CARACTERÍSTICAS TÉCNICAS

- Incluye cuatro bandejas (ARM01).
- Incluye dos bandejas (ARM05).
- Cerradura de tres puntos de cierre.

FEATURES

- Delivered with four shelves included (ARM01).
- Delivered with two shelves included (ARM05).
- Three points locking.

CARACTERISTIQUES TECHNIQUES

- Quatre tablettes inclus (ARM01).
- Deux tablettes inclus (ARM05).
- Fermeture trois points.

CARACTERÍSTICAS TÉCNICAS

- Inclui quatro prateleiras (ARM01).
- Inclui duas prateleiras (ARM05).
- A fechadura fecha em três pontos.



MOD. ARM01
 COD. 19001

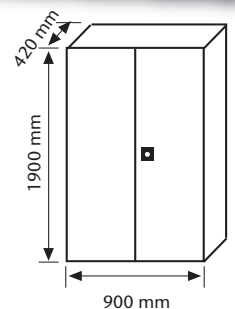





ARMARIO METÁLICO DE PERSIANA PVC

METAL CABINET WITH PVC ROLLING DOOR
 ARMOAIRE METALLIQUE A RIDEAU PVC
 ARMÁRIOS DE ESCRITORIO

NOVEDAD
 EW / NOUVEAU /
 NOVEDADE



MOD. ARMP-19/2
 COD. 19812

MOD. ARMP-19/1 • COD. 19810
 MOD. ARMP-19/2 • COD. 19812

MOD. ARMP-16/1 • COD. 16310
 MOD. ARMP-16/2 • COD. 16312

MOD. ARMP-13/1 • COD. 13410
 MOD. ARMP-13/2 • COD. 13412

MOD. ARMP-10/1 • COD. 10510
 MOD. ARMP-10/2 • COD. 10512

MOD. ARMP-07/1 • COD. 07510
 MOD. ARMP-07/2 • COD. 07512

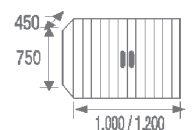
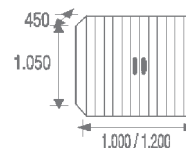
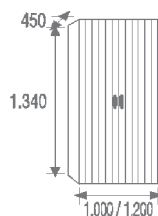
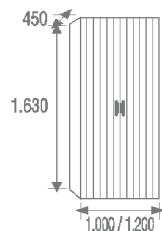
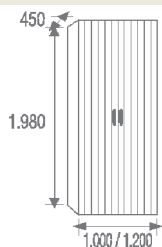

Unidades en milímetros / Units in milimeters / Unités en milimètres / Unidades em milímetros

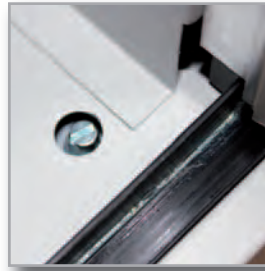
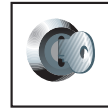
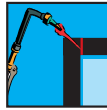

Colores persiana
 Finish for shutters
 Finitions de rideaux
 Cores das portas
RAL 7035, RAL 9006, RAL 9010

TIRADOR EMBUTIDO
 Embossed handle
 Poignée encastrée
 Puxador embutido
RAL 9005

COLORES OPCIONALES CUERPO / OPTIONAL BODY COLOURS / COULEURS EN OPTION CORP / CORES OPCIONAIS CORPO

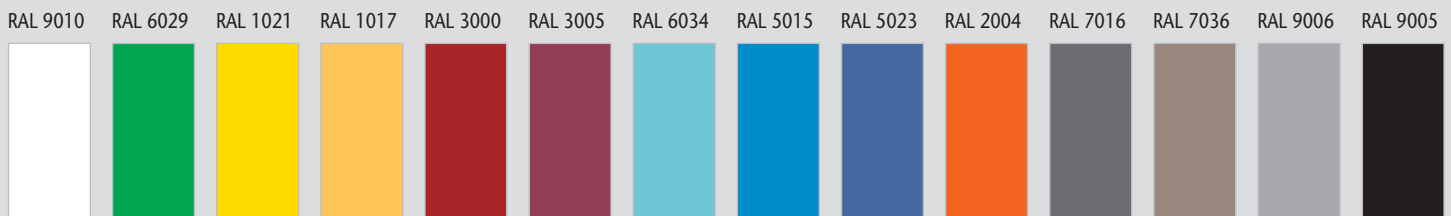

ARCHIVADOR /

OFFICE AND INDUSTRIAL CUPBOARDS
ARMOIRES DE BUREAU ET ATELIER
ARMÁRIOS DE ESCRITORIO

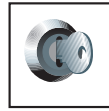
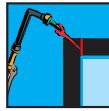

MOD. ARC-4C

MOD. ARC-2C
COD. 20002

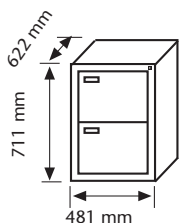

MOD. ARC-3C
COD. 20003

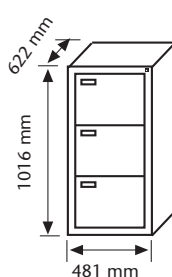

MOD. ARC-4C
COD. 20001

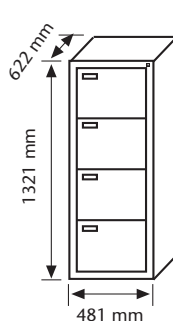

CARACTERÍSTICAS TÉCNICAS

- Guías telescópicas de bolas, extracción total del cajón.
- Sistema antivuelco.
- Soporta 40 Kgs. por cajón.

FEATURES

- Balls bearing runners, fully extending drawers.
- Anti tilt mechanism.
- Maximum drawer load of 40 kg.

CARACTERISTIQUES TECHNIQUES

- Coulisses à billes, extraction totale du tiroir.
- Système anti-basculement.
- Chaque tiroir peut supporter 40 kg.

CARACTERÍSTICAS TÉCNICAS

- Guías telescópicas de bolas, a gaveta abre na totalidade.
- Quando a gaveta abre, ela fica firme, não cae para fora.
- Soporta 40 kg cada gaveta.

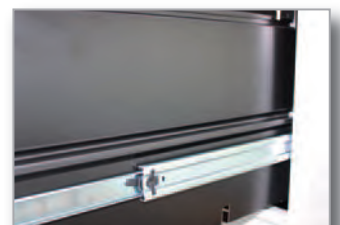

TAQUILLAS INOX / INOX LOCKERS VESTIAIRES INOX ARMÁRIOS DE VESTIÁRIO INOX

OPCIONES
OPTIONS / OPTIONS / OPÇÕES



NOVEDAD
NEW / NOUVEAU /
NOVEDADE

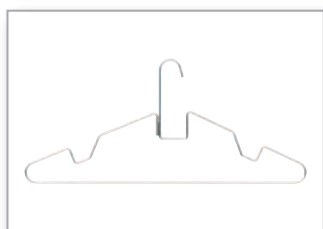
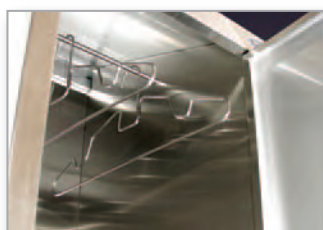
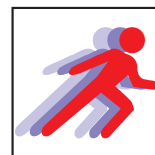
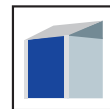
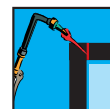

2 PERCHAS INCLUIDAS
2 hooks included
2 cintre inclus
2 cabides



SV-30/1 Inox
COD. 83001

SV-30/2 Inox
COD. 83002

SV-30/3 Inox
COD. 83003

ST-30/1 Inox
COD. 83011

ST-30/2 Inox
COD. 83012

ST-30/3 Inox
COD. 83013

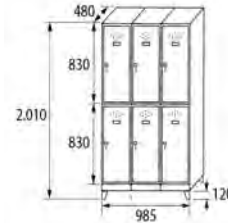
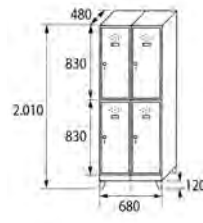
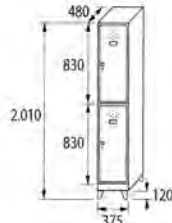
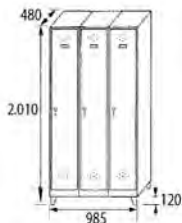
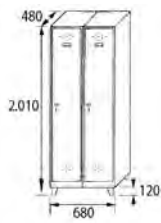
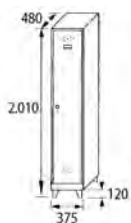

31,0 • 0,38

49,0 • 0,69

67,0 • 0,99

32,0 • 0,38

50,0 • 0,69

68,0 • 0,99

Unidades en milímetros / Units in milimeters / Unités en milimètres / Unidades em milímetros

SERIE EVOLUCIÓN /

SERIES EVOLUTION
SÉRIE EVOLUTION
SÉRIE EVOLUÇÃO

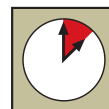

PERFILERÍA DE ALUMINIO. Aluminium profile. Avec profilés. Perfilaria de alumínio.
ESTANTES EN FENÓLICO. HPL shelves. Tablettes en stratifié compact. Prateleiras em resinas fenólicas.



MOD. EVO-1
COD. 99001



MOD. EVO-2
COD. 99002





MÚLTIPLES COMBINACIONES
Multiple combinations.
Beaucoup de combinaisons.
Multiplas combinações.







TAQUILLAS EN MELAMINA /

LOCKERS IN MELAMINE
VESTIAIRES EN MÉLAMINE
CACIFOS FOLHEADO A MADEIRA DE TOLA



OPCIONES / OPTIONS / OPTIONS / OPÇÕES



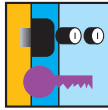
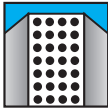
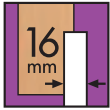

BLANCO-1

MV

MT

NOVEDAD
EW / NOUVEAU /
NOVEDADE

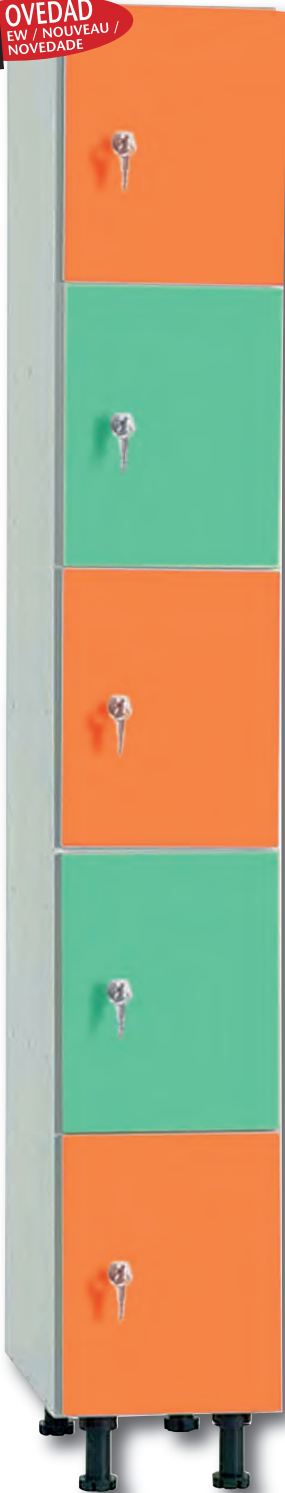

NOVEDAD
EW / NOUVEAU /
NOVEDADE



NOVEDAD
EW / NOUVEAU /
NOVEDADE



COLORES STANDARD PUERTAS / STANDARD DOORS COLOURS / COULEURS PORTES STANDARD / CORES DE PORTAS STANDARD

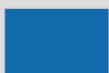

L-021

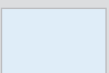

H-017

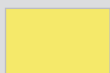

Y-115



J-052



M-168



K-096

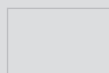

V-157



X-017



S-021

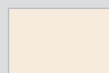

G-097



Z-025

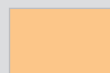

Y-058

COLORES OPCIONALES PUERTAS

OPTIONALS DOORS COLOURS
COULEURS PORTES OPTION
CORES DE PORTAS OPCIONAIS



M-100



M-110



M-120



M-130



M-140



M-150

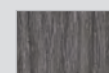

M-160

TAQUILLAS EN MELAMINA /

LOCKERS IN MELAMINE
VESTIAIRES EN MÉLAMINE
CACIFOS FOLHEADO A MADEIRA DE TOLA

SERIE MV

SERIE MT

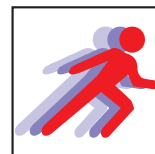

SERIE MV



SERIE MT

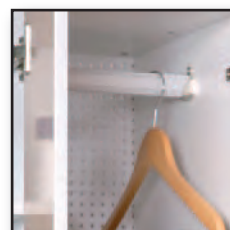

Opción: Puerta en postformado
Option: Door post formed
Option: Porte post-formé
Opção: Porta em postformado

MV-30/C
COD. 99276

MV-40/C
COD. 99283

MT-30/C
COD. 99277

MT-40/C
COD. 99352

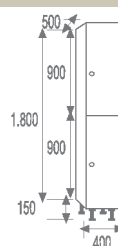
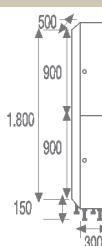
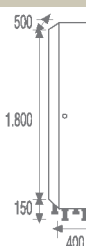

34,50 • 0,29

38,50 • 0,39

35,00 • 0,29

39,00 • 0,39

TAQUILLAS EN MELAMINA /

LOCKERS IN MELAMINE
VESTIAIRES EN MÉLAMINE
CACIFOS FOLHEADO A MADEIRA DE TOLA

SERIE MM



SERIE MC



SERIE MM



SERIE MC



Opción: Puerta Fenólica
Option: Phenolic door
Option: Porte en compact
Opção: Porta fórmica

MM-30/C
COD. 99350

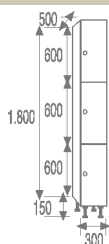

37,00 • 0,29

MM-40/C
COD. 99353

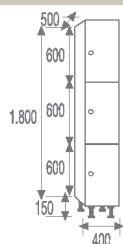

41,50 • 0,39

MC-30/C
COD. 99351

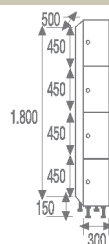

39,00 • 0,29

MC-40/C
COD. 99354

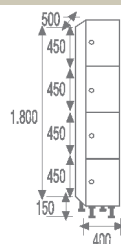

44,00 • 0,39

Unidades en milímetros / Units in milimeters / Unités en milimètres / Unidades em milímetros

TAQUILLAS EN MELAMINA /

LOCKERS IN MELAMINE
VESTIAIRES EN MÉLAMINE
CACIFOS FOLHEADO A MADEIRA DE TOLA

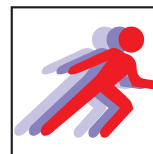

SERIE MP

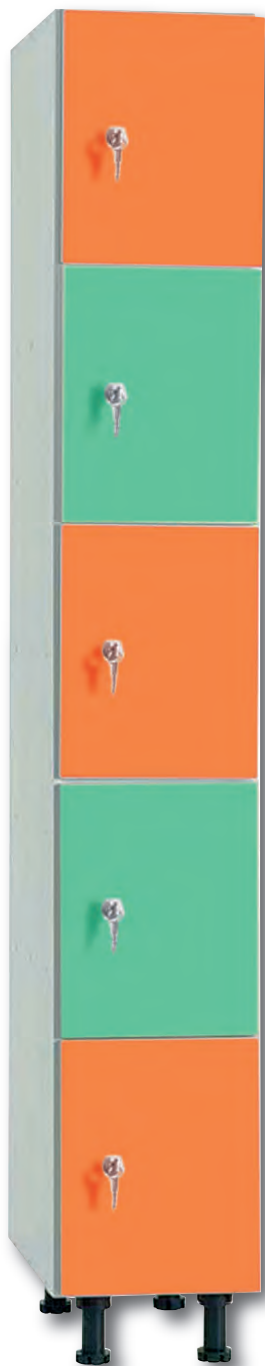

SERIE MB



SERIE MZ



MP-30/1
COD. 99551

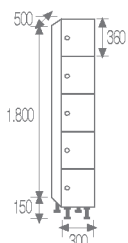

MP-40/1
COD. 99554

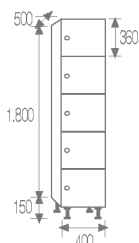

MB-30/1
COD. 99651

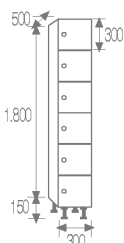

MB-40/1
COD. 99654

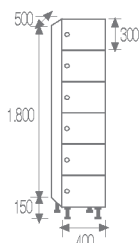

MZ-30/1
COD. 99851

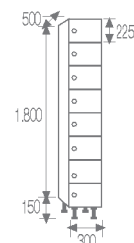

MZ-40/1
COD. 99854

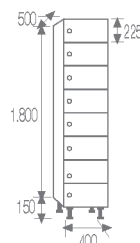

41,00 • 0,29

46,50 • 0,39

43,00 • 0,29

49,00 • 0,39

47,00 • 0,29

54,00 • 0,39

Unidades en milímetros / Units in millimeters / Unités en millimètres / Unidades em milímetros

TAQUILLAS EN MELAMINA /

LOCKERS IN MELAMINE
VESTIAIRES EN MÉLAMINE
CACIFOS FOLHEADO A MADEIRA DE TOLA



TAQUILLAS EN MELAMINA DESMONTABLES

DISASSEMBLED LOCKERS IN MELAMINE
VESTIAIRES DEMONTABLES EN MÉLAMINE
CACIFOS DESMONTÁVEIS FOLHEADO A MADEIRA DE TOLA

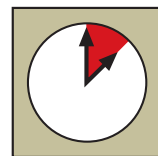
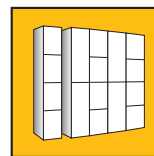

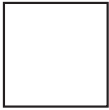
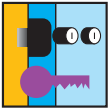
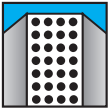
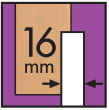

BLANCO-1



MV



MT







TAQUILLAS EN COMPACTO FENÓLICO

PHENOLIC LOCKERS
 VESTIAIRES EN STRATIFIÉ COMPACT AUTOPORTANT
 CACIFOS DE RESINAS FENÓLICAS

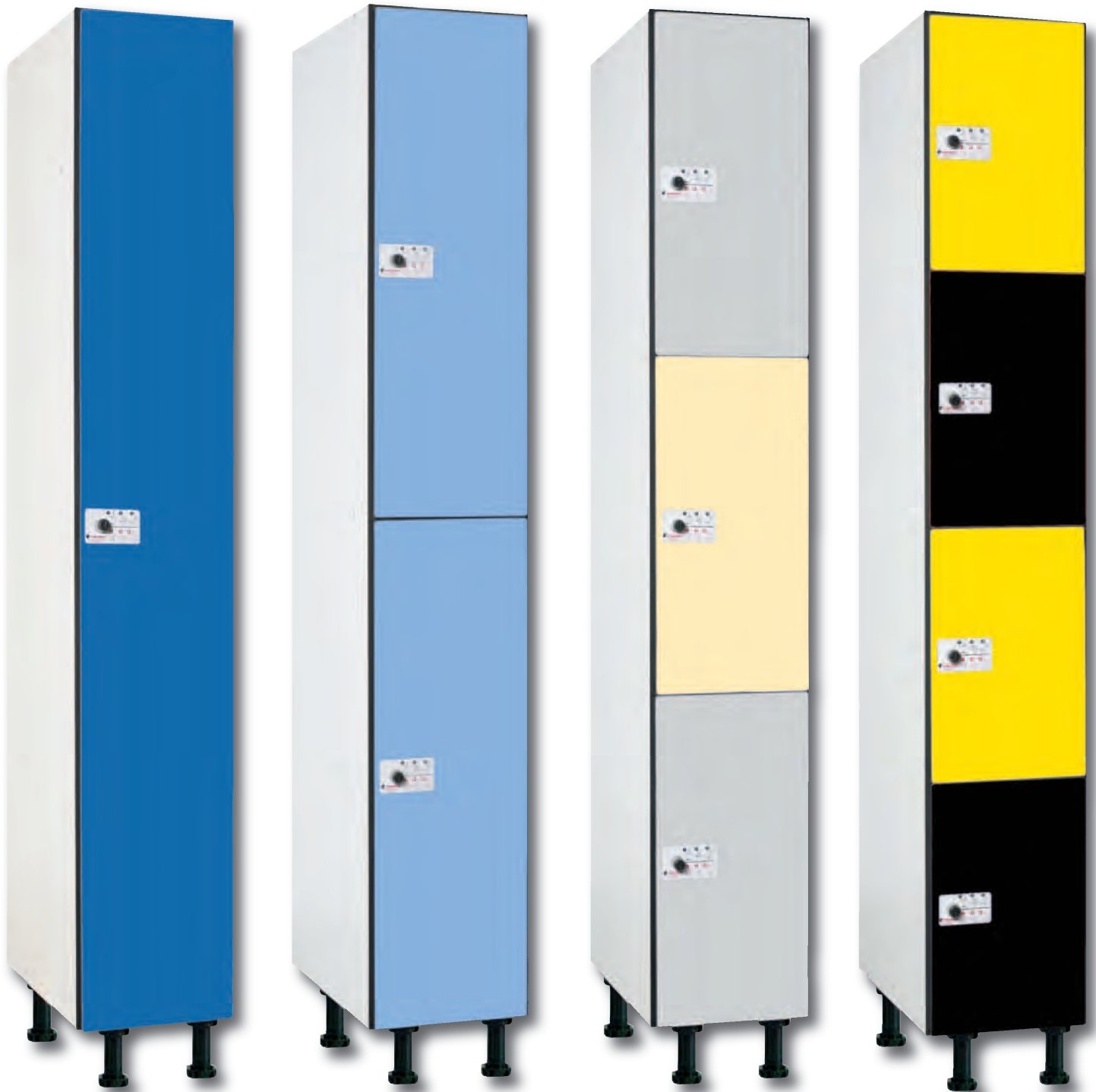
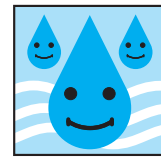

OPCIONES / OPTIONS / OPTIONS / OPÇÕES



Ver pág. 9 / See page 9 / Voir Page 9 / Ver pág. 9

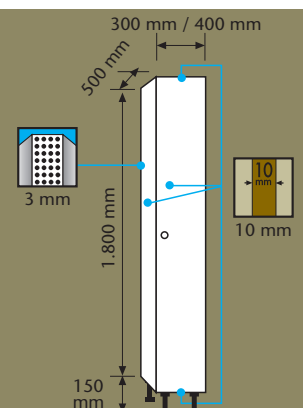

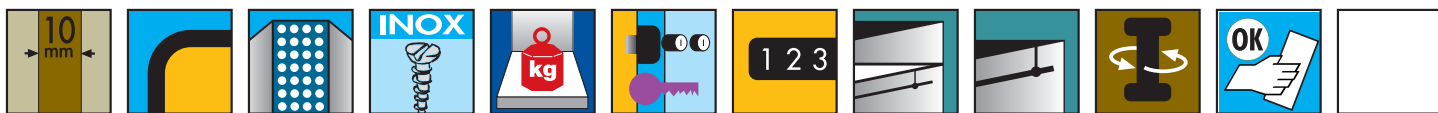

BLANCO-1

NOVEDAD
EW / NOUVEAU /
NOVEDADE

NOVEDAD
EW / NOUVEAU /
NOVEDADE

NOVEDAD
EW / NOUVEAU /
NOVEDADE



COLORES STANDARD PUERTAS / STANDARD DOORS COLOURS / COULEURS PORTES STANDARD / CORES DE PORTAS STANDARD



L-021

BLANCO-1

X-027

V-021

V-097

H-162

Y-018

K-096

M-168

Y-571

OTROS COLORES CONSULTAR

OTHER COLOURS ON REQUEST
AUTRES COULEURS SUR DEMANDE
OUTRAS CORES PERGUNTAR

TAQUILLAS EN COMPACTO FENÓLICO / PHENOLIC LOCKERS

VESTIAIRES EN STRATIFIE COMPACT AUTOPORTAN
CACIFOS DE RESINAS FENÓLICAS

SERIE FV

SERIE FT

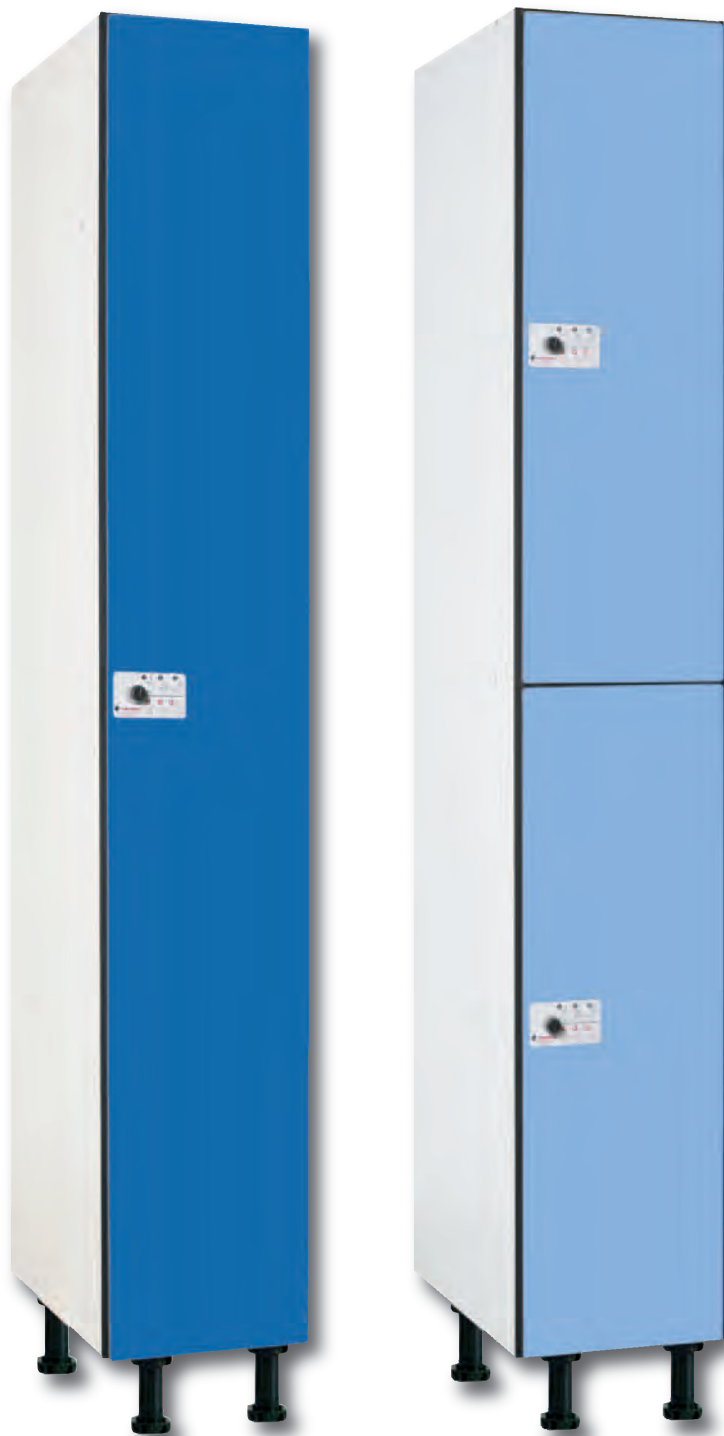
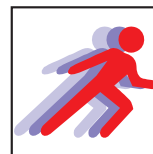

SERIE FV

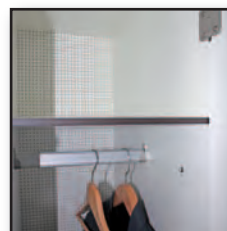

SERIE FT

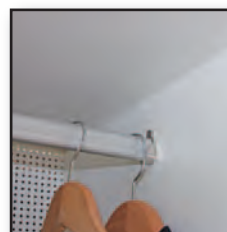

FV-30/C
COD. 53001

FV-40/C
COD. 53002

FT-30/C
COD. 53011

FT-40/C
COD. 53012

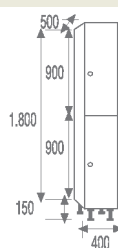
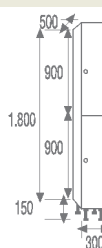
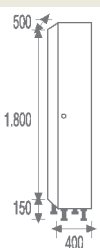
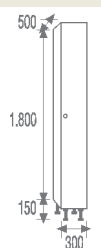

43,0 • 0,29

48,50 • 0,39

44,0 • 0,29

49,0 • 0,39

TAQUILLAS EN COMPACTO FENÓLICO / PHENOLIC LOCKERS

VESTIAIRES EN STRATIFIE COMPACT AUTOPORTAN
CACIFOS DE RESINAS FENÓLICAS

SERIE FM

SERIE FC

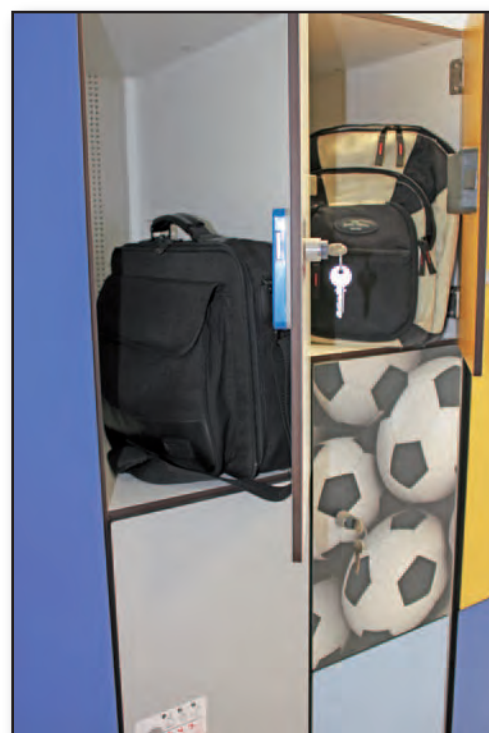
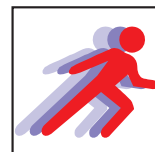

SERIE FM

SERIE FC

FM-30/C
COD. 53031

FM-40/C
COD. 53032

FC-30/C
COD. 53021

FC-40/C
COD. 53022

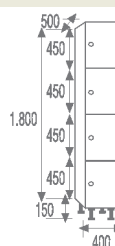
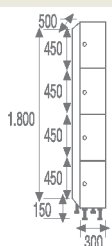
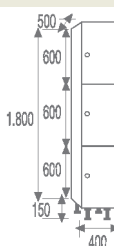
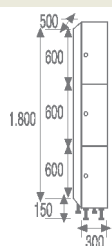

46,50 • 0,29

52,0 • 0,39

49,0 • 0,29

55,0 • 0,39

Unidades en milímetros / Units in milimeters / Unités en milimètres / Unidades em milímetros

TAQUILLAS EN COMPACTO FENÓLICO /

PHENOLIC LOCKERS
VESTIAIRES EN STRATIFIÉ COMPACT AUTOPORTANT
CACIFOS DE RESINAS FENÓLICAS



SERIE FP

SERIE FB

SERIE FZ



FP-30/C
COD. 53051

FP-40/C
COD. 53052

FB-30/C
COD. 53061

FB-40/C
COD. 53062

FZ-30/C
COD. 53081

FZ-40/C
COD. 53082

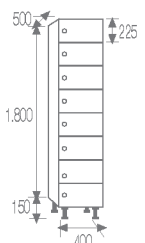
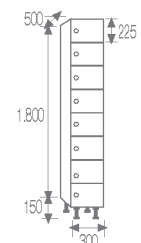
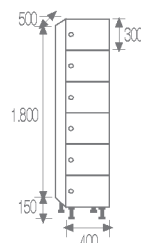
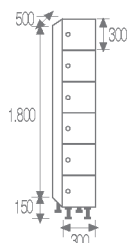
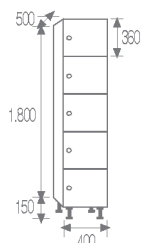
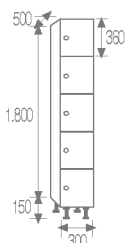

51,50 • 0,29

58,0 • 0,39

54,0 • 0,29

61,0 • 0,39

59,5 • 0,29

67,0 • 0,39

TAQUILLAS EN COMPACTO FENÓLICO / PHENOLIC LOCKERS

VESTIAIRES EN STRATIFIE COMPACT AUTOPORTANT
CACIFOS DE RESINAS FENÓLICAS

SERIE FL

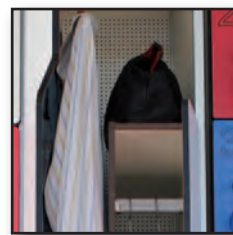

FL-30/C
COD. 53041

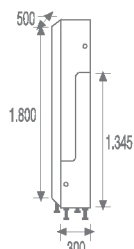

50,50 • 0,29

FL-40/C
COD. 53042

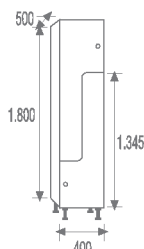

55,0 • 0,39

Unidades en milímetros / Units in milimeters / Unités en milimètres / Unidades em milímetros

TAQUILLAS EN FENÓLICO DESMONTABLES

DISASSEMBLED LOCKERS IN PHENOLIC
VESTIAIRES DEMONTABLES EN STRATIFIE COMPACT
CACIFOS DESMONTÁVEIS DE RESINAS FENÓLICAS

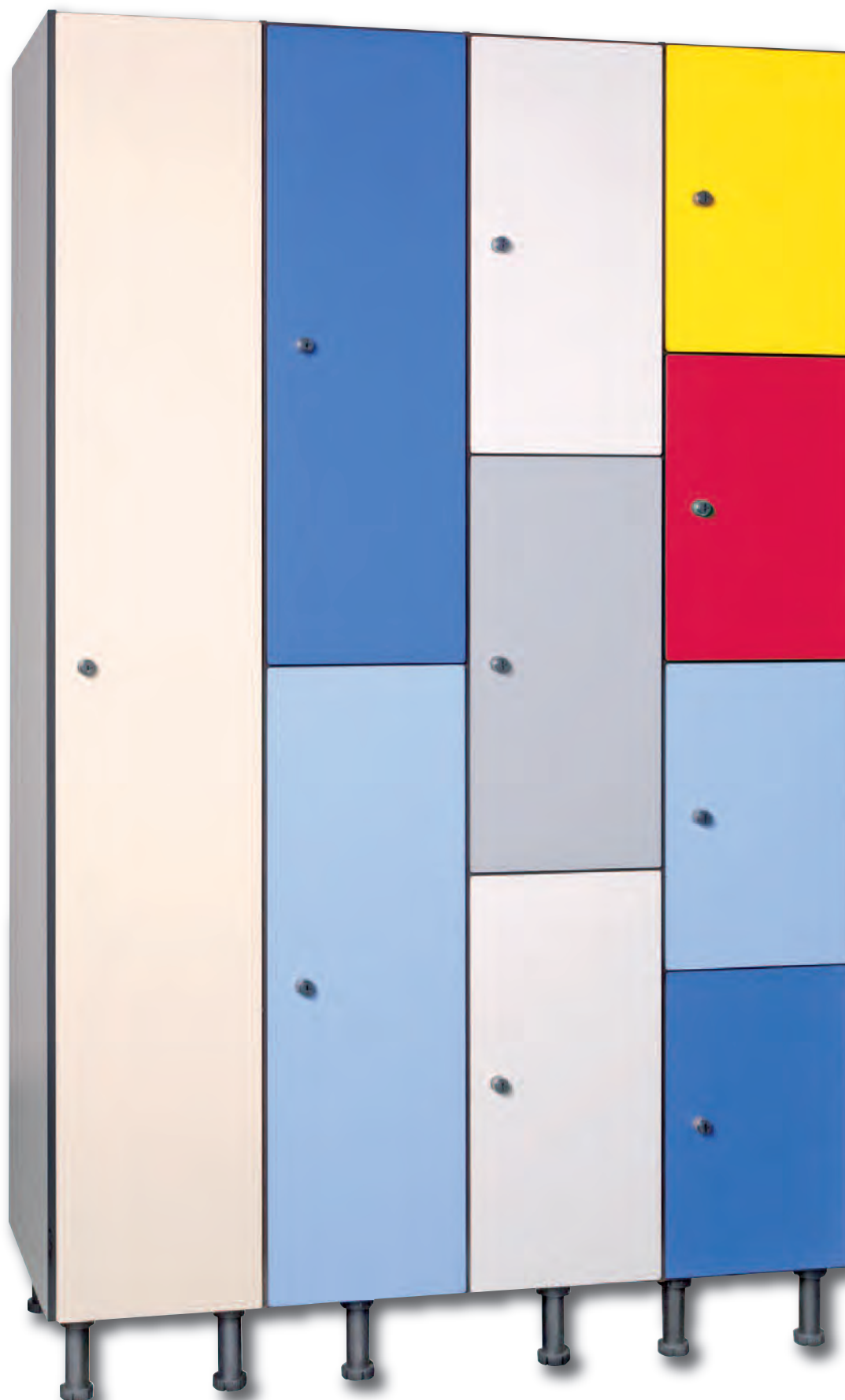
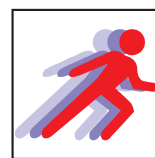
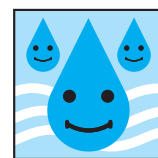

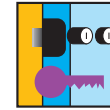
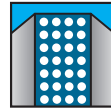
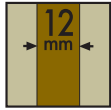

FDV



FDT

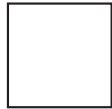

BLANCO-1

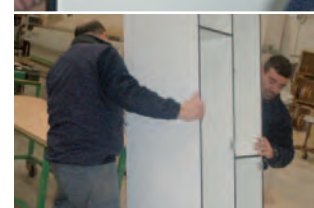
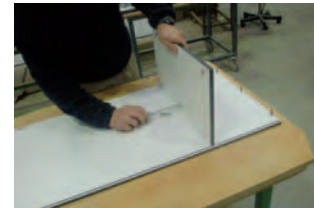

TAQUILLAS EN COMPACTO CON PERFILERÍA

PHENOLIC LOCKERS WITH ALUMINIUM PROFILE
 VESTIAIRES EN COMPACT AVEC PROFILÉS
 CACIFOS DE RESINAS FENÓLICAS COM PERFILARIA DE ALUMÍNIO



OPCIONES / OPTIONS / OPTIONS / OPÇÕES



Ver pág. 9 / See page 9 / Voir Page 9 / Ver pág. 9

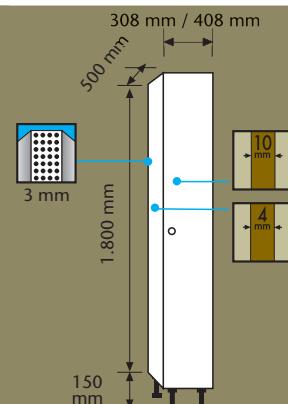



FVP

FTP



BLANCO-1

NOVEDAD
EW / NOUVEAU /
NOVEDADE

NOVEDAD
EW / NOUVEAU /
NOVEDADE

NOVEDAD
EW / NOUVEAU /
NOVEDADE



COLORES STANDARD PUERTAS / STANDARD DOORS COLOURS / COULEURS PORTES STANDARD / CORES DE PORTAS STANDARD



L-021

BLANCO-1

X-027

V-021

V-097

H-162

Y-018

K-096

M-168

Y-571

OTROS COLORES CONSULTAR

OTHER COLOURS ON REQUEST
AUTRES COULEURS SUR DEMANDE
OUTRAS CORES PERGUNTAR

TAQUILLAS EN COMPACTO CON PERFILERÍA /

PHENOLIC LOCKERS WITH ALUMINIUM PROFILE
 VESTIAIRES EN COMPACT AVEC PROFILES
 CACIFOS DE RESINAS FENÓLICAS COM PERFILARIA DE ALUMÍNIO



SERIE FVP

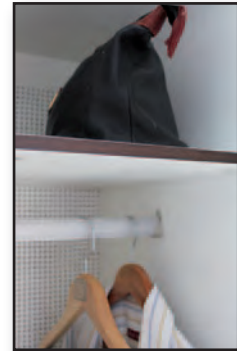

SERIE FTP

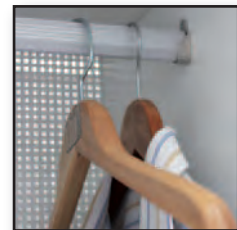

FVP-30/1C COD. 53501	FVP-30/2C COD. 53502	FVP-30/3C COD. 53509	FVP-40/1C COD. 53505	FVP-40/2C COD. 53506	FTP-30/1C COD. 53511	FTP-30/2C COD. 53512	FTP-30/3C COD. 53519	FTP-40/1C COD. 53515	FTP-40/2C COD. 53516
-------------------------	-------------------------	-------------------------	-------------------------	-------------------------	-------------------------	-------------------------	-------------------------	-------------------------	-------------------------

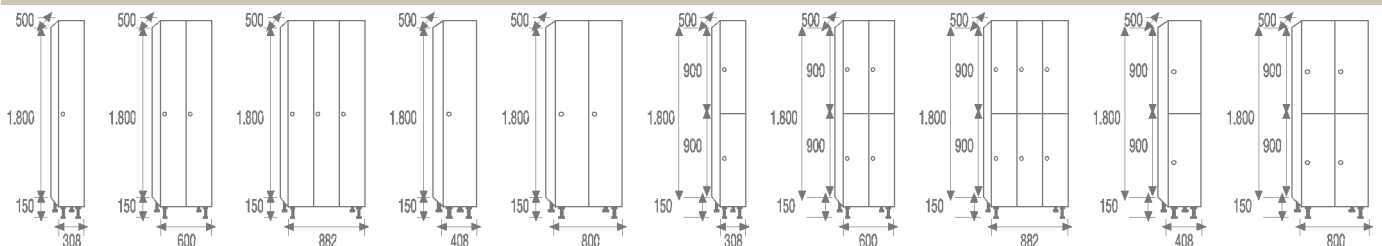

kg	M ³	30,0 • 0,30	53,0 • 0,59	77,0 • 0,86	35,5 • 0,40	65,0 • 0,78	30,5 • 0,30	54,0 • 0,59	78,5 • 0,86	35,0 • 0,40	66,0 • 0,78
----	----------------	-------------	-------------	-------------	-------------	-------------	-------------	-------------	-------------	-------------	-------------

TAQUILLAS EN COMPACTO CON PERFILERÍA /

PHENOLIC LOCKERS WITH ALUMINIUM PROFILE
 VESTIAIRES EN COMPACT AVEC PROFILES
 CACIFOS DE RESINAS FENÓLICAS COM PERFILARIA DE ALUMÍNIO



FMP-30/1C COD. 53531	FMP-30/2C COD. 53532	FMP-30/3C COD. 53539	FMP-40/1C COD. 53535	FMP-40/2C COD. 53536	FCP-30/1C COD. 53521	FCP-30/2C COD. 53522	FCP-30/3C COD. 53529	FCP-40/1C COD. 53525	FCP-40/2C COD. 53526
33,0 • 0,30	59,0 • 0,59	86,0 • 0,86	39,0 • 0,40	73,0 • 0,78	35,5 • 0,30	63,0 • 0,59	93,5 • 0,86	42,0 • 0,40	79,0 • 0,78

Unidades en milímetros / Units in milimeters / Unités en milimètres / Unidades em milímetros

TAQUILLAS EN COMPACTO CON PERFILERÍA /

PHENOLIC LOCKERS WITH ALUMINIUM PROFILE
 VESTIAIRES EN COMPACT AVEC PROFILES
 CACIFOS DE RESINAS FENÓLICAS COM PERFILARIA DE ALUMÍNIO



SERIE FPP



SERIE FBP



SERIE FZP



FPP-30/1C COD. 53551	FPP-30/2C COD. 53552	FPP-30/3C COD. 53559	FPP-40/1C COD. 53555	FPP-40/2C COD. 53556	FBP-30/1C COD. 53561	FBP-30/2C COD. 53562	FBP-30/3C COD. 53569	FBP-40/1C COD. 53565	FBP-40/2C COD. 53566
38,0 • 0,30	68,0 • 0,59	101,0 • 0,86	45,0 • 0,40	85,0 • 0,78	40,50 • 0,30	74,0 • 0,59	108,5 • 0,86	48,0 • 0,40	91,0 • 0,78



TAQUILLAS EN COMPACTO CON PERFILERÍA /

PHENOLIC LOCKERS WITH ALUMINIUM PROFILE
 VESTIAIRES EN COMPACT AVEC PROFILES
 CACIFOS DE RESINAS FENÓLICAS COM PERFILARIA DE ALUMÍNIO

SERIE FLP



FZP-30/1C COD. 53581	FZP-30/2C COD. 53582	FZP-30/3C COD. 53589	FZP-40/1C COD. 53585	FZP-40/2C COD. 53586	FLP-30/1C COD. 53541	FLP-30/2C COD. 53542	FLP-30/3C COD. 53549	FLP-40/1C COD. 53545	FLP-40/2C COD. 53546
45,50 • 0,30	84,0 • 0,59	123,5 • 0,86	54,0 • 0,40	103,0 • 0,78	37,0 • 0,30	67,0 • 0,59	98,0 • 0,86	42,5 • 0,40	79,0 • 0,78

Unidades en milímetros / Units in milimeters / Unités en milimètres / Unidades em milímetros

CABINAS FENÓLICAS /

PHENOLIC CABINS
CABINES PHÉNOLIQUES
CABINES FENÓLICAS



CABINAS FENÓLICAS /

PHENOLIC CABINS
CABINES PHÉNOLIQUES
CABINES FENÓLICAS

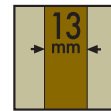

OPCIÓN INOX / OPTION INOX / OPTION INOX / OPÇÃO INOX

COLORES STANDARD / STANDARD COLOURS / COULEURS STANDARD / CORES STANDARD

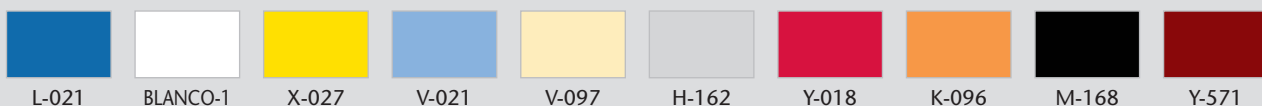

L-021

BLANCO-1

X-027

V-021

V-097

H-162

Y-018

K-096

M-168

Y-571

OTROS COLORES CONSULTAR

OTHER COLOURS ON REQUEST
AUTRES COULEURS SUR DEMANDE
OUTRAS CORES PERGUNTAR

CABINAS FENÓLICAS /

PHENOLIC CABINS
CABINES PHÉNOLIQUES
CABINES FENÓLICAS

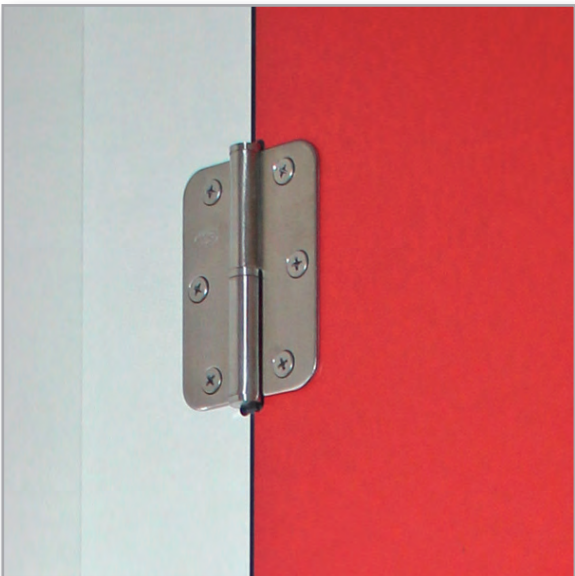

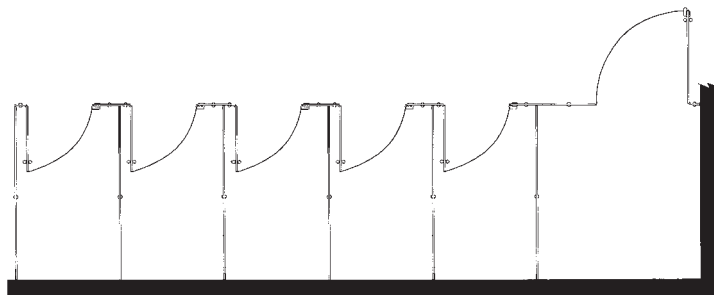
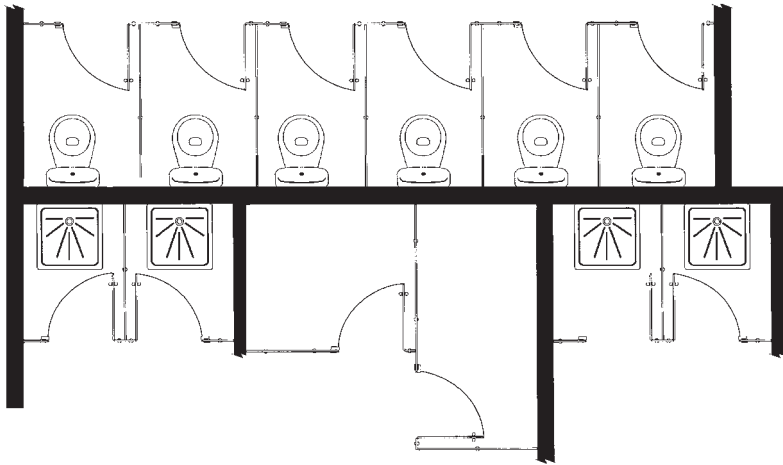
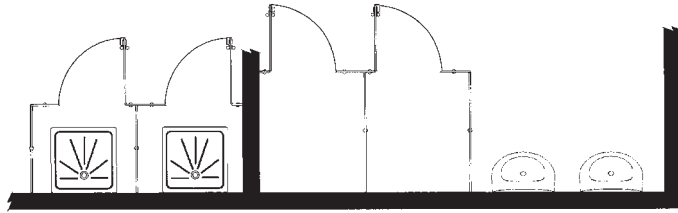
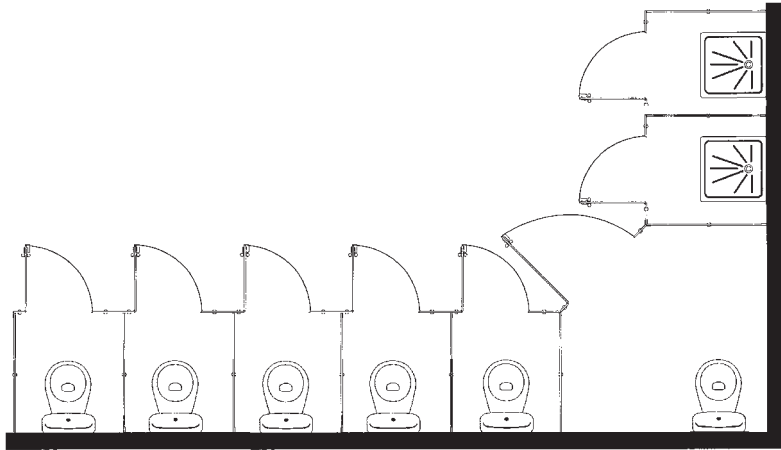

PERSONALIZACIONES / CUSTOMIZATIONS DES PERSONNALISATIONS PERSONALIZAÇÕES



TAQUILLA BOMBEROS
Firemen locker
Vestiaires pompier
Cacifos para bombeiros



PERSONALIZACIONES / CUSTOMIZATIONS DES PERSONNALISATIONS PERSONALIZAÇÕES



TAQUILLA ELECTRIFICABLE
Electrifiable locker
Des casiers électrifiables
Cacifo com tomada



DISTRIBUCIONES INTERIORES
Special distributions
Des distributions spéciales
Distribuições especiais



PERSONALIZACIONES / CUSTOMIZATIONS DES PERSONNALISATIONS PERSONALIZAÇÕES



DIMENSIONES ESPECIALES

Special dimensions
Des dimensions spéciales
Dimensões especiais



MATERIALES ESPECIALES

Special materials
Des matériels spéciaux
Materiais especiais

PERSONALIZACIONES / CUSTOMIZATIONS DES PERSONNALISATIONS PERSONALIZAÇÕES



PUERTAS CON VINOLO FOTOGRAFICO

- Doors with photographic vinyl
- Des portes avec vinyl photographique
- Portas com vinilo

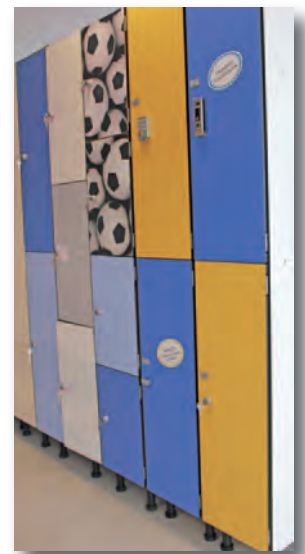

PUERTAS EN CRISTAL

Glass doors • Des portes en cristal • Portas de vidro

BANCOS DE VESTUARIO /

BENCH SEATS
BANCS POUR VESTIAIRES
BANCOS DE VESTIÁRIO

STOCK

BANCOS EN ACERO /

STEEL BENCH SEATS
BANCS EN ACIER
BANCOS EM AÇO

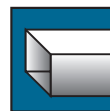
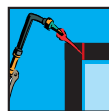

**MICRO
TEXT**



MOD. BANC-H-1500
COD. 79150

COD.	MOD.	↑	←	↘	kg	M ³
79100	BANC-H-1000	530	1000	350	12,0	0,19
79150	BANC-H-1500	530	1500	350	18,0	0,28
79200	BANC-H-2000	530	2000	350	24,0	0,37

BANCOS EN MADERA /

WOODEN BENCH SEATS
BANCS EN BOIS
BANCOS EM MADEIRA

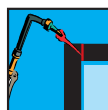

**MICRO
TEXT**



MOD. BANC-1-1500
COD. 79150

COD.	MOD.	↑	←	↘	kg	M ³
79004	BANC-MINI	480	700	325	8,0	0,11
79010	BANC-1-1000	480	1000	325	9,5	0,16
79001	BANC-1-1500	480	1500	325	14,0	0,23
79020	BANC-1-2000	480	2000	325	18,0	0,31

Opción repisa zapatero
Shoe rack option
Option étagère pour chaussures
Opção sapateiro

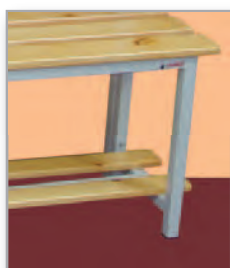

BANCOS DE VESTUARIO /

BENCH SEATS
BANCS POUR VESTIAIRES
BANCOS DE VESTIÁRIO

STOCK

BANCOS EN MADERA /

WOODEN BENCH SEATS
BANCS EN BOIS
BANCOS EM MADEIRA

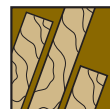
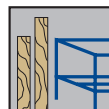

MICRO TEXT



MOD. BANC-PLE
COD. 79003

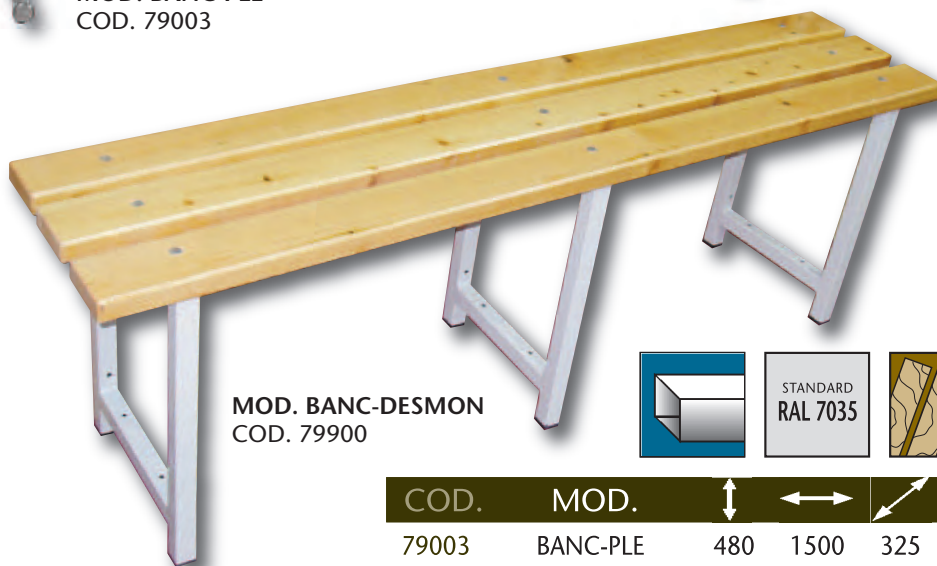

MOD. BANC-DESMON
COD. 79900

MICRO TEXT



COD.	MOD.	↑	←	↗	kg	M ³
79003	BANC-PLE	480	1500	325	9,0	0,23
79900	BANC-DESMON	480	1500	325	11,1	0,23

COLGADORES /

WALL COAT HOOK
PATERES
CABIDES



MOD. COLG-3-2000
COD. 79920



MOD. COLG-2-1500
COD. 79915



MOD. COLG-1-1000
COD. 79910

MOD. COLG-6-900
COD. 79960

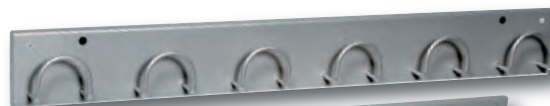

MOD. COLG-5-600
COD. 79955



MOD. COLG-4-400
COD. 79950



BANCOS DE VESTUARIO /

BENCH SEATS
BANCS POUR VESTIAIRES
BANCOS DE VESTIÁRIO

STOCK

BANCOS EN MADERA /

WOODEN BENCH SEATS
BANCS EN BOIS
BANCOS EM MADEIRA

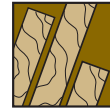
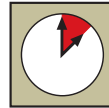
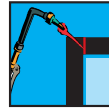

**MICRO
TEXT**



MOD. BANC-2-1500
COD. 79013



Opción repisa zapatero
Shoe rack option
Option étagère pour chaussures
Opção sapateiro

COD.	MOD.	↑	↔	↗	⌋	kg	M ³
79012	BANC-2-1000	1745	1000	355	4	16,0	0,23
79013	BANC-2-1500	1745	1500	355	7	24,0	0,30
79014	BANC-2-2000	1745	2000	355	9	29,0	0,31



MOD. BANC-2-1500 DC
COD. 79213



Opción repisa zapatero
Shoe rack option
Option étagère pour chaussures
Opção sapateiro

COD.	MOD.	↑	↔	↗	⌋	kg	M ³
79212	BANC-2-1000 DC	1745	1000	700	8	28,0	0,46
79213	BANC-2-1500 DC	1745	1500	700	12	42,0	0,60
79214	BANC-2-2000 DC	1745	2000	700	16	52,0	0,62

BANCOS DE VESTUARIO /

BENCH SEATS
BANCS POUR VESTIAIRES
BANCOS DE VESTIÁRIO

STOCK

BANCOS EN MADERA /

WOODEN BENCH SEATS
BANCS EN BOIS
BANCOS EM MADEIRA



MOD. BANC-3-1500
COD. 79023



Opción repisa zapatero
Shoe rack option
Option étagère pour chaussures
Opção sapateiro

COD.	MOD.	↑	↔	↗	↓	kg	M ³
79022	BANC-3-1000	1800	1000	355	4	21,5	0,23
79023	BANC-3-1500	1800	1500	355	7	28,5	0,30
79024	BANC-3-2000	1800	2000	355	9	33,5	0,31



MOD. BANC-3-1500 DC
COD. 79223



Opción repisa zapatero
Shoe rack option
Option étagère pour chaussures
Opção sapateiro

COD.	MOD.	↑	↔	↗	↓	kg	M ³
79222	BANC-3-1000 DC	1800	1000	700	8	37,0	0,23
79223	BANC-3-1500 DC	1800	1500	700	12	51,0	0,30
79224	BANC-3-2000 DC	1800	2000	700	16	61,0	0,31

BANCOS DE VESTUARIO /

BENCH SEATS
BANCS POUR VESTIAIRES
BANCOS DE VESTIÁRIO

STOCK

BANCOS EN PVC /

PVC BENCH SEATS
BANCS EN PVC
BANCOS EM PVC

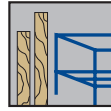
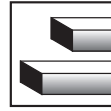

GRIS / GREY
GRIS / CINZA



MOD. BANC1-PVC-1500
COD. 79102



MOD. BANC1-PVC-1000
COD. 79101



COD.	MOD.	↑	←	↗	kg	M ³
79101	BANC1-PVC-1000	480	1000	400	7,0	0,19
79102	BANC1-PVC-1500	480	1500	400	9,0	0,29
79103	BANC1-PVC-2000	480	2000	400	12,0	0,38

BANCOS DE VESTUARIO /

BENCH SEATS
BANCS POUR VESTIAIRES
BANCOS DE VESTIÁRIO

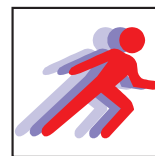

MOD. BANC-FI-1500
COD. 79006

**MICRO
TEXT**

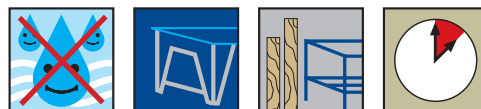

COD.	MOD.	↑	←	↗	kg	M ³
79005	BANC-FI-1000	460	1000	325	11,7	0,15
79006	BANC-FI-1500	460	1500	325	17,5	0,22
79007	BANC-FI-2000	460	2000	325	20,5	0,30



MOD. BANC-ME-1500
COD. 79009

**MICRO
TEXT**



COD.	MOD.	↑	←	↗	kg	M ³
79008	BANC-ME-1000	480	1000	325	12,0	0,19
79009	BANC-ME-1500	480	1500	325	16,5	0,29
79011	BANC-ME-2000	480	2000	325	20,5	0,38



MOD. BANC-MHD-1500
COD. 79016

**MICRO
TEXT**

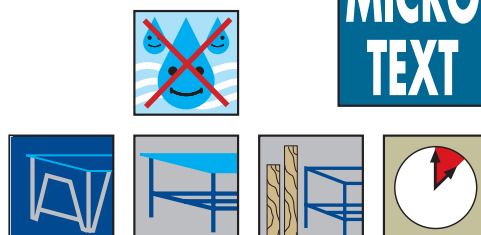

COD.	MOD.	↑	←	↗	kg	M ³
79015	BANC-MHD-1000	460	1000	325	12,0	0,15
79016	BANC-MHD-1500	460	1500	325	16,5	0,22
79017	BANC-MHD-2000	460	2000	325	20,5	0,30

BANCOS Y MESAS DE ALUMINIO

BENCHES AND TABLES IN ALUMINIUM
 BANCS ET TABLES EN ALUMINIUM
 BANCOS E MESAS EM ALUMINIO

PERFIL DE ALUMINIO

Aluminium profile / Profils aluminium / Perfilaría de aluminio

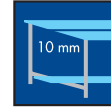
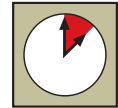

1000 - 1500 - 2000 mm

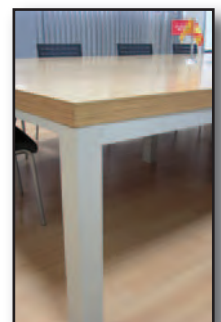
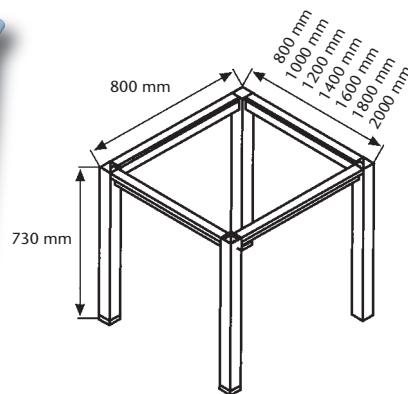

BANCOS DE VESTUARIO /

BENCH SEATS
BANCS POUR VESTIAIRES
BANCOS DE VESTIÁRIO

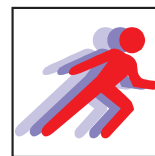

BANCOS EN FENÓLICO /

PHENOLIC BENCH SEATS
BANCS EN STRATIFIÉ MASSIF
BANCOS EM FÓRMICA

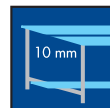
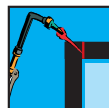

MOD. BANC-1-1500-FEN
COD. 79502

COD.	MOD.	↑	←	↗	kg	M ³
79501	BANC-1-1000-FEN	480	1000	340	12,0	0,16
79502	BANC-1-1500-FEN	480	1500	340	18,0	0,24
79503	BANC-1-2000-FEN	480	2000	340	24,0	0,33
79510	BANC-PARED 1000-FEN	330	1000	400	9,0	0,13
79511	BANC-PARED 1500-FEN	330	1500	400	15,0	0,20
79512	BANC-PARED 2000-FEN	330	2000	400	21,0	0,26



MOD. BANC-PARED 1500-FEN
COD. 79511

COLORES STANDARD PUERTAS / STANDARD DOORS COLOURS / COULEURS PORTES STANDARD / CORES DE PORTAS STANDARD



L-021

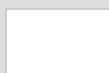

BLANCO-1



X-027



V-021

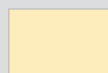

V-097

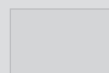

H-162



Y-018



K-096

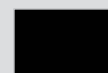

M-168



Y-571

OTROS COLORES CONSULTAR

OTHER COLOURS ON REQUEST
AUTRES COULEURS SUR DEMANDE
OUTRAS CORES PERGUNTAR

BANCOS DE VESTUARIO /

BENCH SEATS
BANCS POUR VESTIAIRES
BANCOS DE VESTIÁRIO

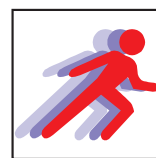

BANCOS EN FENÓLICO

PHENOLIC BENCH SEATS
BANCS EN STRATIFIÉ MASSIF
BANCOS EM FÓRMICA

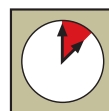
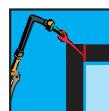
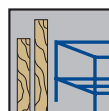
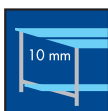

MOD. BANC-2-1500-FEN
COD. 79505



MOD. BANC-3-1500-FEN
COD. 79508

**MICRO
TEXT**

COD.	MOD.	↑	←	↗	↓	kg	M ³
79504	BANC-2-1000-FEN	1745	1000	370	5	24,0	0,23
79505	BANC-2-1500-FEN	1745	1500	370	8	32,0	0,30
79506	BANC-2-2000-FEN	1745	2000	370	10	37,0	0,31

COD.	MOD.	↑	←	↗	↓	kg	M ³
79507	BANC-3-1000-FEN	1800	1000	370	5	31,5	0,23
79508	BANC-3-1500-FEN	1800	1500	370	8	38,5	0,30
79509	BANC-3-2000-FEN	1800	2000	370	10	43,5	0,31

COLGADORES / WALL COAT HOOK PATERES CABIDES



MOD. PER-FEN-1000
COD. 79930

COD.	MOD.	↑	←	↓	kg	M ³
79930	PER-FEN-1000	110	1000	5	3,0	0,009
79931	PER-FEN-1500	110	1500	8	5,0	0,013
79932	PER-FEN-2000	110	2000	10	8,0	0,018

REPISAS / SHELVES ETAGERES PRATELEIRA EM FÓRMICA PARA COLOCAR SACOLAS



MOD. REP-FEN-1500
COD. 79941

COD.	MOD.	↑	←	↗	↓	kg	M ³
79940	REP-FEN-1000	270	1000	400	5	8,0	0,11
79941	REP-FEN-1500	270	1500	400	8	11,0	0,16
79942	REP-FEN-2000	270	2000	400	10	14,0	0,22

BANCOS DE VESTUARIO /

BENCH SEATS
BANCS POUR VESTIAIRES
BANCOS DE VESTIÁRIO



BANCOS EN FENÓLICO DOBLE CARA /

PHENOLIC BENCH SEATS
BANCS EN STRATIFIÉ MASSIF
BANCOS EM FÓRMICA

NOVEDAD
EW / NOUVEAU /
NOVEDADE



MOD. BANC-3-1000-FEN DC
COD. 79557



MOD. BANC-2-1000-FEN DC
COD. 79554

COD.	MOD.	↑	↔	↗	↓	kg	M ³
79557	BANC-3-1000-FEN DC	1745	1000	710	10	48	0,46
79558	BANC-3-1500-FEN DC	1745	1500	710	16	64	0,60
79559	BANC-3-2000-FEN DC	1745	2000	710	20	74	0,62

COD.	MOD.	↑	↔	↗	↓	kg	M ³
79554	BANC-2-1000-FEN DC	1745	1000	710	10	63	0,46
79555	BANC-2-1500-FEN DC	1745	1500	710	16	77	0,60
79556	BANC-2-2000-FEN DC	1745	2000	710	20	87	0,62

MESAS, BANCOS Y SILLAS PLEGABLES /

TABLES, BENCHES AND CHAIRS FOLDING
TABLES, BANCS ET CHAISES PLIANTES
MESAS, BANCOS E CADEIRAS DOBRÁVEIS

MESA PLEGABLE / FOLDING TABLE TABLE PLIANTE MESA DOBRÁVEL

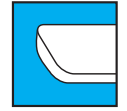
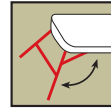

STOCK



50

MOD. MP-2000
COD. 99405



1830 740 760

Camping, playa, casetas de obra...
Camping, beach, Sheds of work...
Camping, plage, maisonnette de chantier...
Camping, praia, construção



930 110 770 16,5 0,078

BANCO PLEGABLE / FOLDING BENCH BANC PLIANTE BANCO DOBRÁVEL



40

MOD. BP-2000
COD. 99406



1830 250 430

CONJUNTO DE 2 UNIDADES
SET 2 UNITS
LOT 2 UNITÉS
CONJUNTO DE 2 UNS

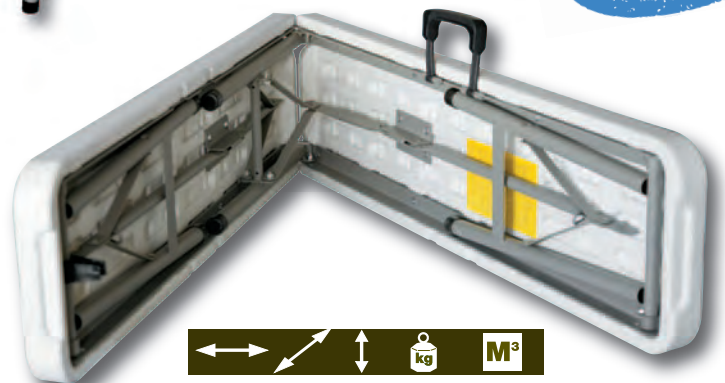

930 100 260 9,0 0,024

MESAS, BANCOS Y SILLAS PLEGABLES /

TABLES, BENCHES AND CHAIRS FOLDING
TABLES, BANCS ET CHAISES PLIANTES
MESAS, BANCOS E CADEIRAS DOBRÁVEIS

SILLA PLEGABLE /

FOLDING CHAIR
CHAISES PLIANTE
CADEIRA DOBRÁVEL



CONJUNTO DE 4 UNIDADES
SET 4 UNITS
LOT 4 UNITÉS
CONJUNTO DE 4 UNIS

MOD. SP-900
COD. 99408

450 420 900

470 350 110 5,0 0,018

BANCOS Y MESAS PLEGABLES /

FOLDING TABLE AND BENCHES
TABLE ET BANCS PLIANTES
BANCOS E CADEIRAS DOBRÁVEIS

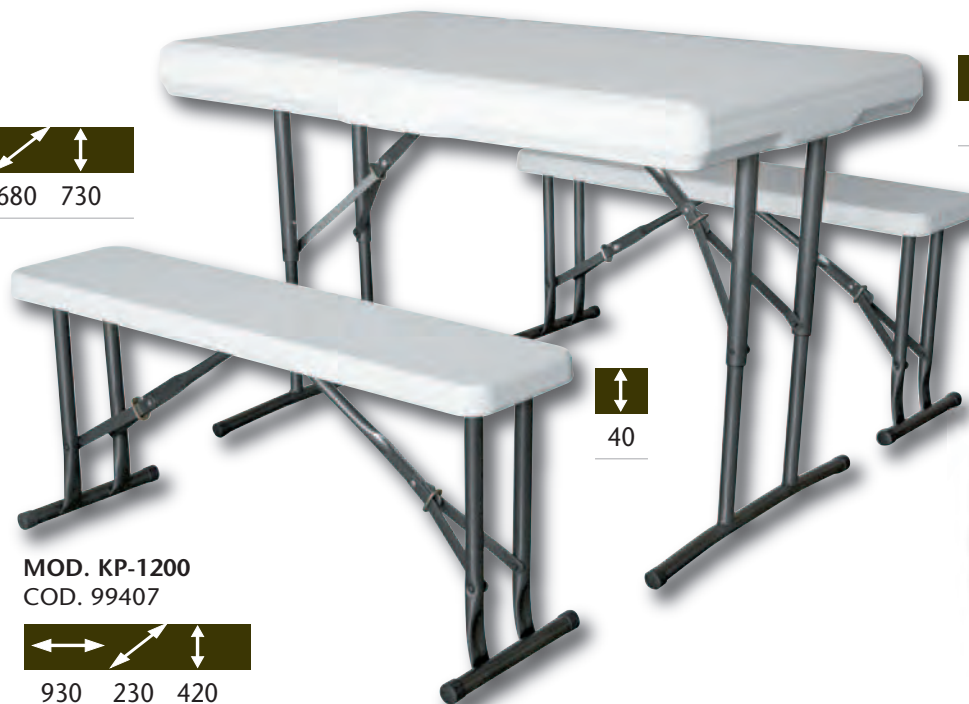

CONJUNTO 3 EN 1
SET 3 IN 1
LOT 3 EN 1
CONJUNTO 3 EN 1

95



40

MOD. KP-1200
COD. 99407

930 230 420

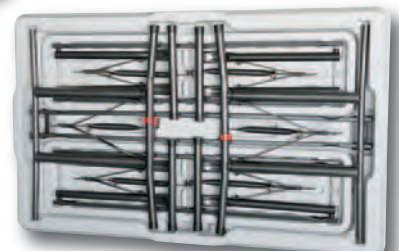

1160 110 690 20,5 0,088

ACCESORIOS VESTUARIO / LOCKERS ACCESSORIES ACCESSOIRES POUR VESTIAIRES MOBILIÁRIO PARA O BANHEIRO

SECAMANOS ELÉCTRICO ELECTRIC HAND DRYERS / SÈCHE-MAINS ELECTRIQUE / SECAMÃOS ELÉTRICO



MOD. SMP-1P
COD. 01500

MOD. SMP-2M
COD. 01600

MOD. SMP-3I
COD. 01700

SECADORES DE PELO HAIR DRYERS / SÈCHE-CHEVEUX SECADOR DE CABELO



MOD. SPP-1P
COD. 02001

MOD. SPP-ZP
COD. 02002



DISPENSADORES DE PAPEL PAPER DISPENSERS / DISTRIBUTEUR DE PAPIER / DOSIFICADOR DE PAPEL



MOD. DPCI-15000
COD. 15000

MOD. DPCA-20000
COD. 20000

MOD. DPRI-25000
COD. 25000

MOD. DPRA-30000
COD. 30000

INOX

ABS

INOX

ABS



DISPENSADORES DE JABÓN SOAP DISPENSERS / DISTRIBUTEUR DE SAVON DOSIFICADOR DE SABÃO



MOD. DJ-I-INOX
COD. 00489

MOD. DJ-P-ABS
COD. 51001

INOX

ABS

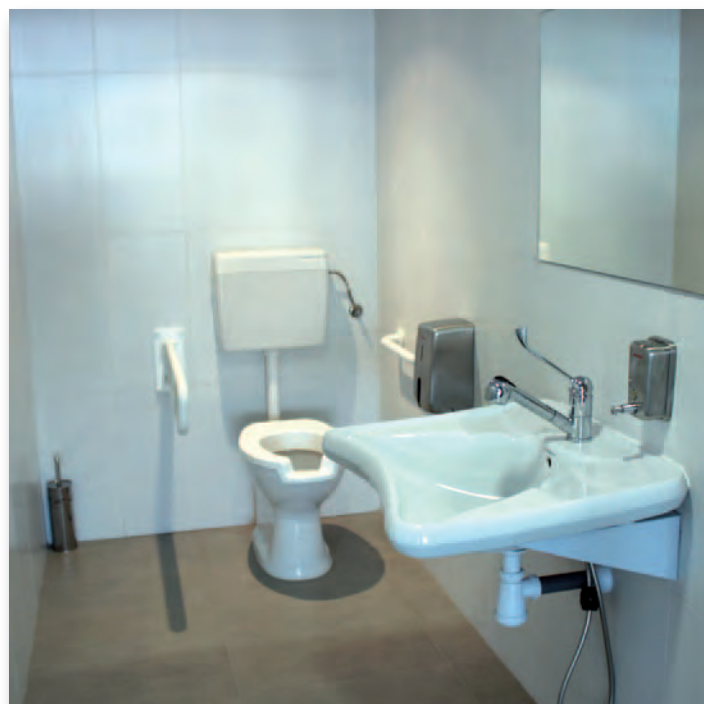

ACCESORIOS VESTUARIO /

LOCKERS ACCESSORIES
ACCESSOIRES POUR VESTIAIRES
MOBILIÁRIO PARA O BANHEIRO

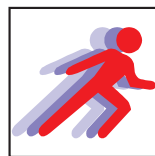

PAPERERAS EN ACERO

STEEL WASTEPAPER BINS / CORBEILLES A PAPIERS EN ACIER / LATA DE LIXO EM AÇO



MOD. PAP100
COD. 60010

INOX



MOD. PAP900
COD. 60090



MOD. PAP 500
COD. 60100

INOX

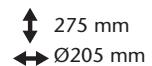

MOD. PAP800
COD. 60800

ACCESORIOS BAÑOS

BATH ACCESSORIES / ACCESSOIRES BAIGNE / ACCESORIOS BAHNO



MOD. PORTA-2
COD. 40300



MOD. ESCOB-1
COD. 40400



MOD. PSM-1
COD. 40500

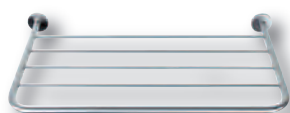

MOD. REP-1
COD. 41500

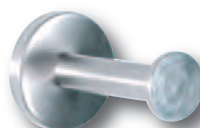

MOD. PER-1
COD. 40100

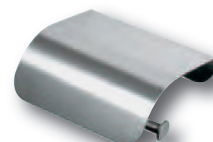

MOD. PORTA-1
COD. 41100

AYUDAS TÉCNICAS

TECHNICAL AIDS / AIDES TECHNIQUES / AJUDADES TÉCNICAS



INOX MOD. ATR-11
COD. 00300

ABS MOD. ATR-1A
COD. 05909



ABS MOD. ATL-1A
COD. 06409

INOX MOD. ATL-11
COD. 06509



ABS MOD. AAP-ABS
COD. 01108

INOX MOD. AAP-INOX
COD. 01100

ABS MOD. AT90-1A
COD. 606509

INOX MOD. AT90-11
COD. 600700



ARENEROS

STEEL WASTEPAPER BINS / CORBEILLES A PAPIERS EN ACIER / LATA DE LIXO EM AÇO



MOD. ARE10
COD. 88010



MOD. PAP20
COD. 87020

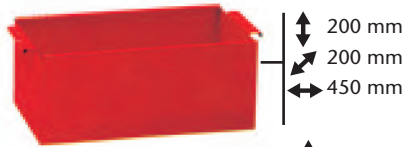

MOD. ARE20
COD. 88020



MOD. PAP10
COD. 87010





CONSIGNAS / LEFT-LUGGAGE LOCKERS CONSIGNES CACIFOS

**MICRO
TEXT**



OPCIONES / OPTIONS / OPTIONS / OPÇÕES



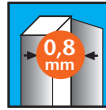
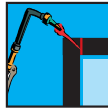

ME
TAL

E
PO
XI

STANDARD
RAL 7035

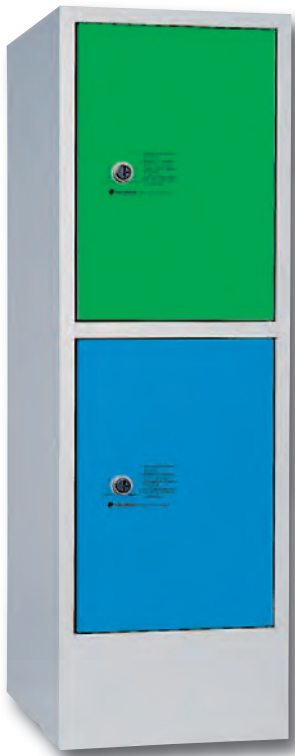

COLORES OPCIONALES / OPTIONAL COLOURS / COULEURS EN OPTION / CORES OPCIONAIS

RAL 9010 RAL 6029 RAL 1021 RAL 1017 RAL 3000 RAL 3005 RAL 6034 RAL 5015 RAL 5023 RAL 2004 RAL 7016 RAL 7036 RAL 9006 RAL 9005



CONSIGNAS / LEFT-LUGGAGE LOCKERS CONSIGNES CACIFOS

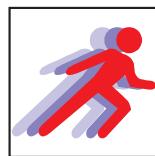

SERIE BANCO / BANCO SERIES SÉRIE BANCO SÉRIE BANCO



 MOD. TBC03P
COD. 91300



 MOD. CBC04P
COD. 91402

COD.	MOD.	↑	↔	↗	□	⊙	⊙	⊙	kg	M ³
91400	TBC04P	915	275	440	4	✓	-	16,0	0,11	
91402	CBC04P	915	275	440	4	-	✓	17,5	0,11	
91300	TBC03P	690	275	440	3	✓	-	13,0	0,08	
91302	CBC03P	690	275	440	3	-	✓	14,0	0,08	

SERIE MINI / MINI SERIES SÉRIE MINI SÉRIE MINI



 MOD. MINI5P
COD. 91000



 MOD. TMIN4P
COD. 91200



 MOD. CMIN3P
COD. 91102

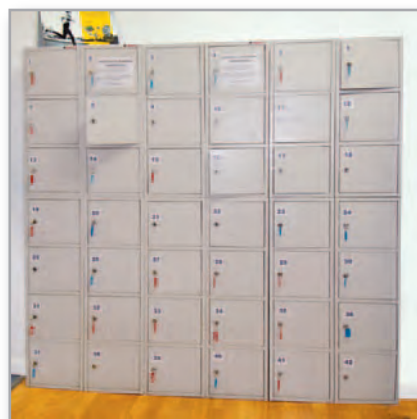

COD.	MOD.	↑	↔	↗	□	⊙	⊙	⊙	kg	M ³
91200	TMIN4P	915	275	200	4	✓	-	13,5	0,05	
91202	CMIN4P	915	275	200	4	-	✓	12,0	0,05	
91100	TMIN3P	690	275	200	3	✓	-	9,0	0,04	
91102	CMIN3P	690	275	200	3	-	✓	10,0	0,04	
91000	MINI5P	750	200	200	5	✓	-	9,0	0,03	

CONSIGNAS / LEFT-LUGGAGE LOCKERS CONSIGNES CACIFOS



SERIE SUPERMERCADO VERTICAL / SUPERMERCADO VERTICAL SERIES SÉRIE SUPERMERCADO VERTICAL SÉRIE SUPERMERCADO VERTICAL

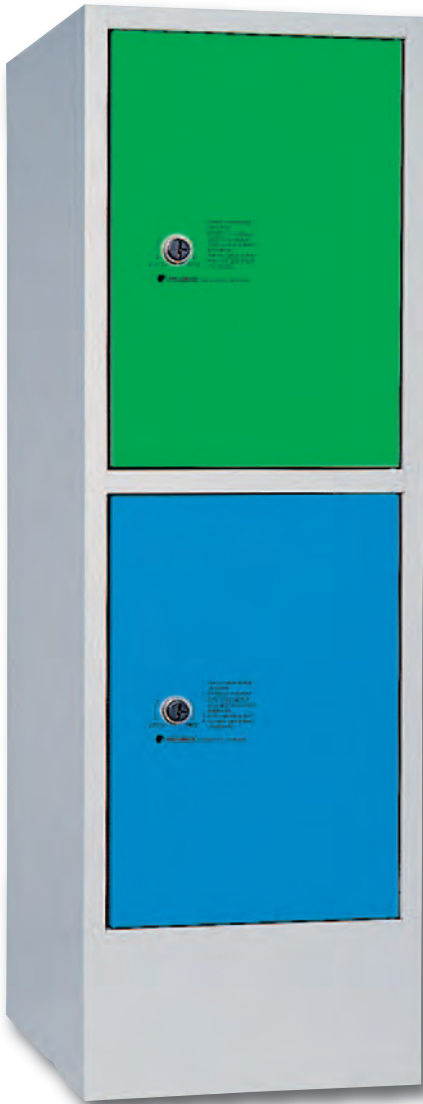

MOD. CSVZ2P
COD. 95302



MOD. TSVS2P
COD. 95400



MOD. CSVS1P
COD. 95502



COD.	MOD.	↑	↔	↗	□	🔒	🔔	📦	⚖️	M ³
95300	TSVZ2P	925	300	400	2	✓	-	13,0	0,11	
95302	CSVZ2P	925	300	400	2	-	✓	14,0	0,11	
95400	TSVS2P	800	300	400	2	✓	-	12,0	0,10	
95402	CSVS2P	800	300	400	2	-	✓	13,0	0,10	
95500	TSVS1P	400	300	400	1	✓	-	7,0	0,05	
95502	CSVS1P	400	300	400	1	-	✓	7,5	0,05	

CONSIGNAS / LEFT-LUGGAGE LOCKERS CONSIGNES CACIFOS



SERIE SUPERMERCADO MECRILATO / SUPERMERCADO METACRILATO SERIES SÉRIE SUPERMERCADO METACRILATO SÉRIE SUPERMERCADO METACRILATO



PUERTA DE METACRILATO DE 5 MM
METHACRYLATE DOOR 5 MM
PORTE METHACRYLATE DE 5 MM
PORTA DE METACRILATO DE 5 MM



MOD. TSVZ2PME
COD. 95333



MOD. CSVS2PME
COD. 95403



MOD. CSVS1PME
COD. 95503

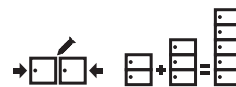

COD.	MOD.	↑	↔	↗	□	🔑	🔒	📦	M ³
95333	TSVZ2PME	925	300	400	2	✓	-	14,0	0,11
95303	CSVZ2PME	925	300	400	2	-	✓	15,0	0,11
95433	TSVS2PME	800	300	400	2	✓	-	13,0	0,10
95403	CSVS2PME	800	300	400	2	-	✓	14,0	0,10
95533	TSVS1PME	400	300	400	1	✓	-	8,0	0,05
95503	CSVS1PME	400	300	400	1	-	✓	8,5	0,05

CONSIGNAS / LEFT-LUGGAGE LOCKERS CONSIGNES CACIFOS

CUERPO/BODY/
CORPS/CORPO
RAL 9006
PUERTA/DOOR/
PORTE/PORTA
RAL 5015



SERIE MONOBLOK MECRILATO / MONOBLOCK METACRILATO SERIES MONOBLOCK METACRILATO SERIES SÉRIE MONOBLOCK METACRILATO

**MICRO
TEXT**



**PUERTA DE
METACRILATO DE 10 MM**
METHACRYLATE DOOR 10 MM
PORTE METHACRYLATE DE 10 MM
POR DE METACRILATO DE 10 MM

**CONTROL VISUAL DE LOS
OBJETOS DEPOSITADOS**
VISUAL CONTROL OF STORED OBJECTS
CONTROLE VISUEL DES OBJETS DEPOSES
CONTROLE VISUAL DOS OBJETOS DEPOSITADOS

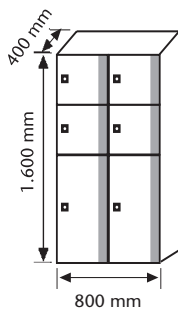

MOD. CM3P1600-D
COD. 42912

22,0 0,19 <p>COD: 42802 MOD: CM2P1200-S</p>	44,0 0,38 <p>COD: 42812 MOD: CM2P1200-D</p>	25,0 0,26 <p>COD: 42902 MOD: CM2P1600-S</p>	28,0 0,26 <p>COD: 42913 MOD: CM4P1600-S</p>	53,0 0,51 <p>COD: 42912 MOD: CM3P1600-D</p>
24,0 0,19 <p>COD: 42803 MOD: CM3P1200-S</p>	48,0 0,38 <p>COD: 42813 MOD: CM3P1200-D</p>	26,0 0,26 <p>COD: 42904 MOD: CM3P1600-S</p>	50,0 0,51 <p>COD: 42903 MOD: CM2P1600-D</p>	55,0 0,51 <p>COD: 42914 MOD: CM4P1600-D</p>

Unidades en milímetros / Units in milimeters / Unités en milimètres / Unidades em milímetros

CONSIGNAS / LEFT-LUGGAGE LOCKERS CONSIGNES CACIFOS



SERIE SUPERMERCADO HORIZONTAL / SUPERMERCADO HORIZONTAL SERIES SÉRIE SUPERMERCADO HORIZONTAL SÉRIE SUPERMERCADO HORIZONTAL



MOD. CSH3P
COD. 95202



MOD. TSH2P
COD. 95100

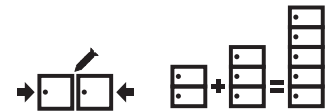

COD.	MOD.	↑	↔	↗	□	🔑	🚪	📦	M ³
95200	TSH3P	410	870	400	3	✓	-	19,0	0,14
95202	CSH3P	410	870	400	3	-	✓	21,0	0,14
95100	TSH2P	410	580	400	2	✓	-	13,0	0,09
95102	CSH2P	410	580	400	2	-	✓	12,0	0,09

SERIE MAXI / MAXI SERIES SÉRIE MAXI SÉRIE MAXI



MOD. CMAXI1P
COD. 97300



COD.	MOD.	↑	↔	↗	□	🔑	🚪	📦	M ³
97305	TMAXI1P	1170	300	500	1	✓	-	12,0	0,18
97300	CMAXI1P	1170	300	500	1	-	✓	13,0	0,18
95600	TSV2PMAXI	800	300	500	2	✓	-	14,0	0,12
95602	CSV2PMAXI	800	300	500	2	-	✓	15,0	0,12



MOD. TSVS2PMAXI
COD. 95500

CONSIGNAS / LEFT-LUGGAGE LOCKERS CONSIGNES CACIFOS

SERIE MARCO AMARRE / MARCO AMARRE SERIES SÉRIE MARCO AMARRE SÉRIE MARCO AMARRE

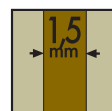

RAL 9010

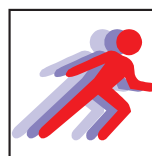

**MICRO
TEXT**



MOD. MA4P1500
COD. 90422



COD.	MOD.	↑	←	↘	🔑	kg	M ³
90222	MA4P900	1170	900	400	5	18,5	0,08
90322	MA4P1200	1170	1200	400	6	21,0	0,09
90422	MA4P1500	1170	1500	400	8	23,5	0,10

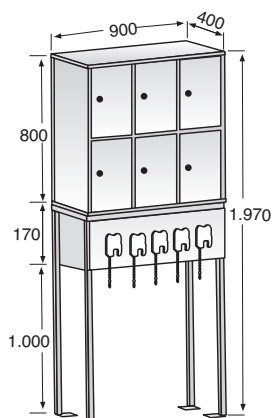

3 CSV2P + 1 MA900

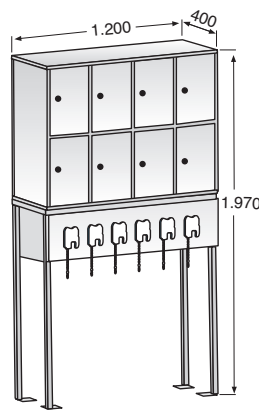

4 CSVS2P + 1 MA1200

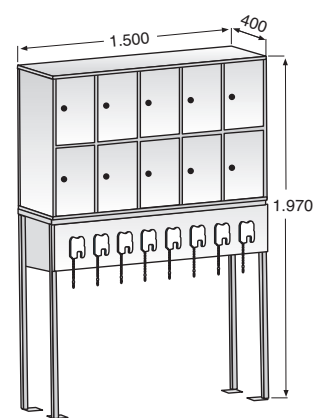

5 CSVS2P + 1 MA1500

CONSIGNAS /

LEFT-LUGGAGE LOCKERS
CONSIGNES
CACIFOS



SERIE GOLF /

GOLF SERIES
SÉRIE GOLF
SÉRIE GOLF



MOD. TGOLF1P
COD. 99600

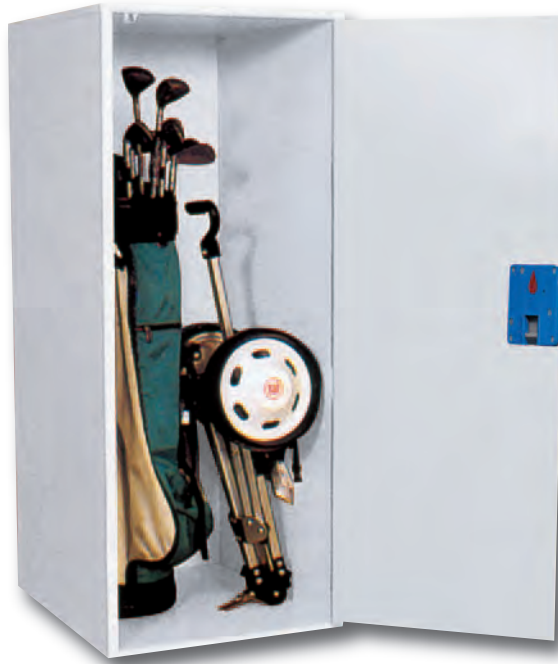

MOD. CGOLF1P
COD. 99500



COD.	MOD.	↑	↔	↗	🔒	🔑	📊	M ³
99500	CGOLF1P	1240	500	600	-	✓	22,0	0,37
99600	TGOLF1P	1240	500	600	✓	-	21,0	0,37

SERIE MALETAS /

SUITCASE SERIES
SÉRIE VALISES
SÉRIE MALAS



MOD. CMAL1P
COD. 97500



COD.	MOD.	↑	↔	↗	🔒	🔑	📊	M ³
97500	CMAL1P	900	500	700	-	✓	39,0	0,31

CONSIGNAS / LEFT-LUGGAGE LOCKERS CONSIGNES CACIFOS

SERIE METACRILATO / METACRILATO SERIES SÉRIE METACRILATO SÉRIE METACRILATO

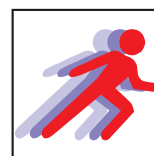

**MICRO
TEXT**



DEPARTAMENTOS / COMPARTMENTS CASIERS / CACIFOS

SERIE 350 / 350 SERIES
SÉRIE 350
SÉRIE 350

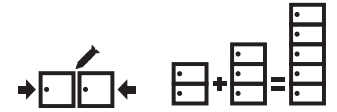
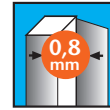
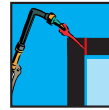

DEP353+CON352



MOD. CON353
COD. 35031



MOD. DEP352
COD. 35020



MOD. CON351
COD. 35011



OPCIONES / OPTIONS / OPTIONS / OPÇÕES

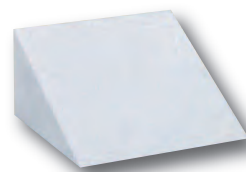

SOBRETECHO
SLOPE TOP / TOIT INCLINÉ /
SOBRETETO COM PEQUENA
INCLINAÇÃO
MOD. SOB350
COD. 35100



ZÓCALO
BASE / SOCLE / SOCLO
MOD. ZOC350
COD. 35000

Ver pág. 9 / See page 9 / Voir Page 9 / Ver pág. 9

DEPARTAMENTOS / COMPARTMENTS

CASIERS
CACIFOS



SERIE LOCKER

LOCKER SERIES
SÉRIE LOCKER
SÉRIE LOCKER



MOD. LOC300
COD. 30010



SERIE 400

400 SERIES
SÉRIE 400
SÉRIE 400



MOD. CON402
COD. 40021

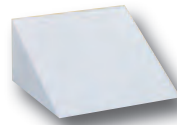

SOBRETECHO

SLOPE TOP / TOIT INCLINÉ /
SOBRETETO COM PEQUENA
INCLINAÇÃO

MOD. SOB400
COD. 40100



ZÓCALO

BASE / SOCLE / SOCLO
MOD. ZOC400
COD. 40000

SERIE MINIBOX

MINIBOX SERIES
SÉRIE MINIBOX
SÉRIE MINIBOX



MOD. BOX8P
COD. 11301

SERIE 500 /

500 SERIES
SÉRIE 500
SÉRIE 500



MOD. DEP1B
COD. 50035



MOD. DEP2B
COD. 50015



COD.	MOD.	↑	↔	↗	□	🔒	🔑	📏	⚖️	M ³
40020	DEP402	900	400	500	2	✓	-	15,0	0,18	
40021	CON402	900	400	500	2	-	✓	16,0	0,18	
50015	DEP2B	700	350	350	1	✓	-	16,0	0,09	
50035	DEP1B	1050	350	350	1	✓	-	14,0	0,13	
30010	LOC300	500	300	450	1	✓	-	8,0	0,07	
11301	BOX8P	1130	345	350	8	✓	-	22,0	0,14	

COLORES OPCIONALES / OPTIONAL COLOURS / COULEURS EN OPTION / CORES OPCIONAIS

RAL 9010

RAL 6029

RAL 1021

RAL 3000

RAL 5015

RAL 5023

RAL 5010

RAL 2004

RAL 7016

RAL 9006

RAL 9005

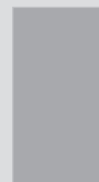

ARMARIOS EN RESINA DE POLIPROPILENO

POLYPROPYLENE RESIN CUPBOARDS
 ARMOIRES EN RESINE DE POLYPROPYLENE
 ARMÁRIOS EM RESINA DE POLIPROPILENE

STOCK

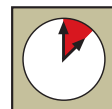
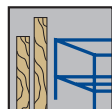
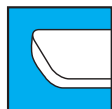

STANDARD
RAL 7035

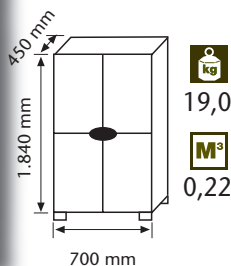

MOD. RP-1
COD. 99101

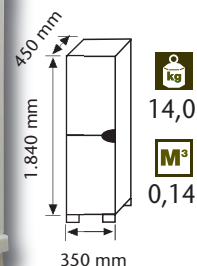

MOD. RP-3
COD. 99103

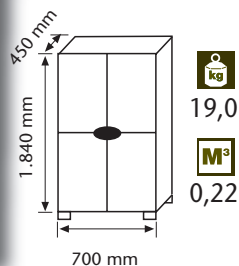

MOD. RP-2
COD. 99102



RP-3



RP-1 / RP-2



RP-4

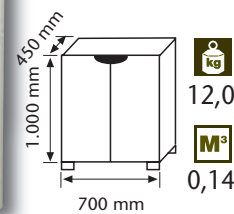

MOD. RP-4
COD. 99104



TAQUILLAS A.B.S. / A.B.S. LOCKERS ARMOIRES EN A.B.S. ARMÁRIOS EM A.B.S.

STOCK

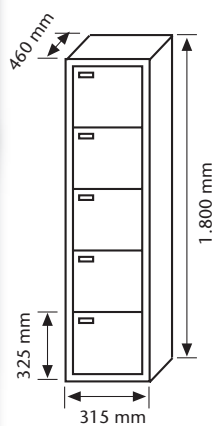
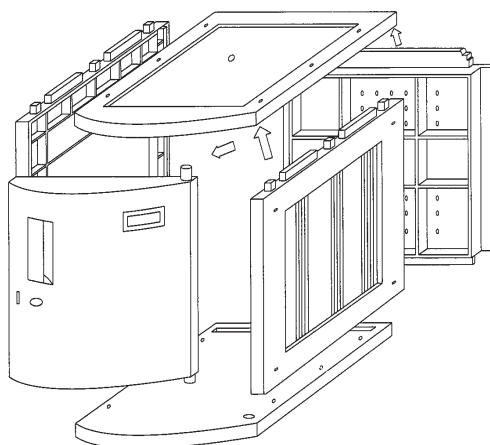
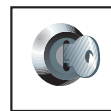
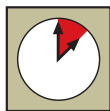

MOD. ABS-5
COD. 99015



TAQUILLAS PLÁSTICO /

PLASTIC LOCKERS
VESTIAIRES EN PLÁSTIQUE
ARMÁRIOS EM PLÁSTICO

CUERPO/BODY/
CORPS/CORPO
PUERTA/DOOR/
PORTE/PORTA

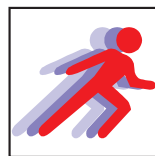

COLORES OPCIONALES PARA PUERTAS / OPTIONAL COLOURS FOR DOORS / COULEURS EN OPTION DE PORTES / CORES OPCIONAIS DE PORTAS

Rojo, Red, Rouge, Vermelho



Gris, Grey, Gris, Cinza

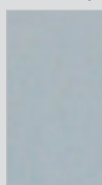

Beige, Beige, Beige, Beige

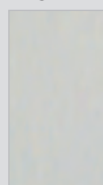

TAQUILLAS PLÁSTICO /

PLASTIC LOCKERS
VESTIAIRES EN PLÁSTIQUE
ARMÁRIOS EM PLÁSTICO

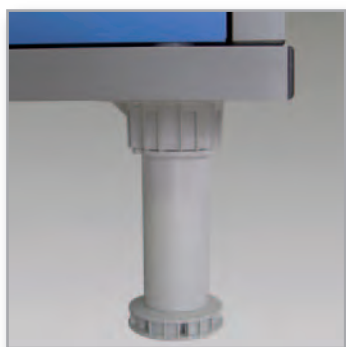
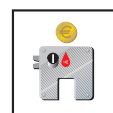
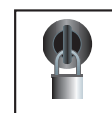
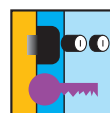
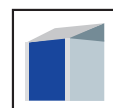

MOD. PT

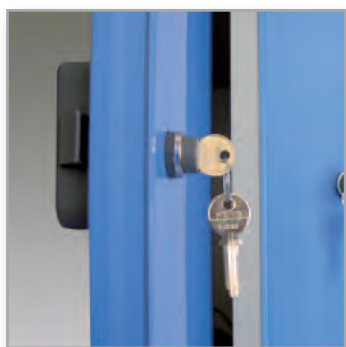

MOD. PV



Resinas de polivinilo.

Polyvinyl resins.

Résines en polivinilo.

Resinas de polivinilo.

Condición contra el fuego M1 (autoextinguible)
según norma UNE 23727.

Condition against the fire M1 (auto-extinguishable)
according to standard UNE 23727.

Condition contre le feu M1 (autoexterminable)
selon la norme UNE 23727.

Condição contra o fogo M1 (autoextingível)
segundo a norma UNE 23727.

TAQUILLAS PLÁSTICO /

PLASTIC LOCKERS
VESTIAIRES EN PLÁSTIQUE
ARMÁRIOS EM PLÁSTICO

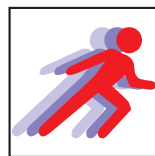

PV-30/1 COD. 22001 **PV-30/2** COD. 22002 **PV-30/3** COD. 22003 **PV-40/1** COD. 22006 **PV-40/2** COD. 22007 **PV-40/3** COD. 22008



PT-30/1 COD. 22011 **PT-30/2** COD. 22012 **PT-30/3** COD. 22013 **PT-40/1** COD. 22016 **PT-40/2** COD. 22017 **PT-40/3** COD. 22018

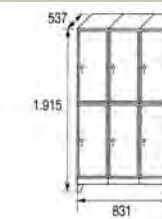
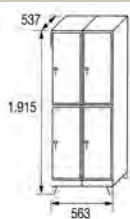
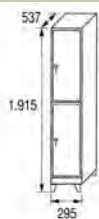

PM-30/1 COD. 22021 **PM-30/2** COD. 22022 **PM-30/3** COD. 22023 **PM-40/1** COD. 22026 **PM-40/2** COD. 22027 **PM-40/3** COD. 22028

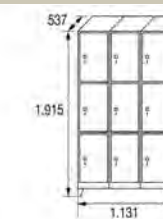
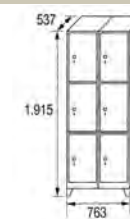
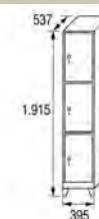
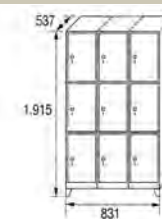
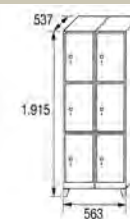
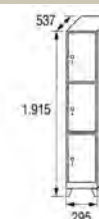

PC-30/1 COD. 22031 **PC-30/2** COD. 22032 **PC-30/3** COD. 22033 **PC-40/1** COD. 22036 **PC-40/2** COD. 22037 **PC-40/3** COD. 22038

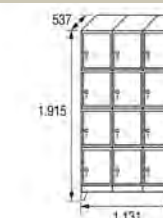
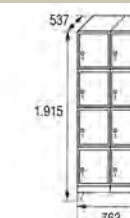
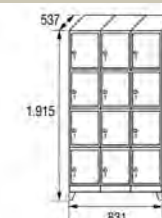
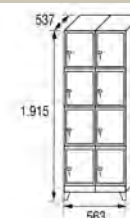
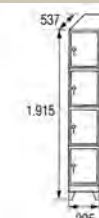

TAQUILLAS PLÁSTICO /

PLASTIC LOCKERS
VESTIAIRES EN PLÁSTIQUE
ARMÁRIOS EM PLÁSTICO

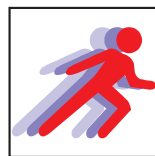

LOSETAS ENROLLABLES / ROLLED FLOOR TILE DALLES ROULABLES PAVIMENTOS QUE PODEM SER ENROLADOS

COLORES / COLOURS / COULEURS / CORES:



Polideportivos, gimnasios, vestuarios, piscinas...

Sport centers, gymnasiums, changing rooms, swimming pools... / Installations sportives, gymnases, vestiaires, piscines... / Ginásios, vestiários, piscinas...

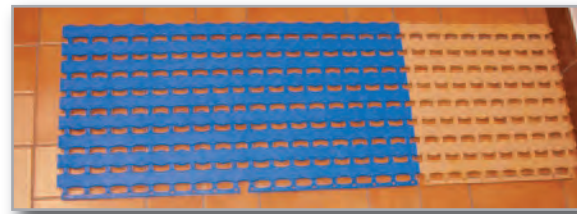
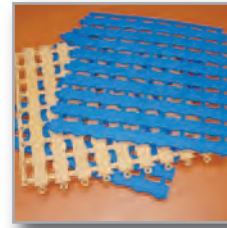
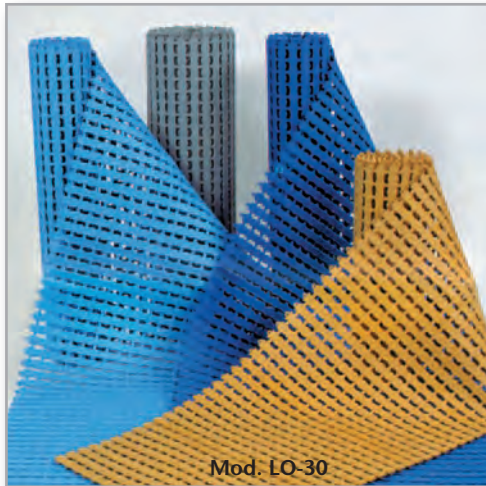

CARACTERÍSTICAS TÉCNICAS GENERALES LOSETA ENROLLABLE DECO

• Dimensiones: 333 x 333 x 15 mm. • Peso: 500 Grs. • Material: Poliéstileno antideslizante EVA estabilizado. • Higiénica. Tratada con Sanitized, Antideslizante, Autoengarce, Sin Mantenimiento.

GENERAL FEATURES DECO ROLLED FLOOR TILE

• Measures: 333 x 333 x 15 mm. • Weight: 500 Grs. • Material: Non-skid Polyethylene stabilized EVA. • Hygienic. Sanitized treated, Non-skid relief, Self connection, Without maintenance.

CARACTERISTIQUES TECHNIQUES GÉNÉRAUX DALLE ROULABLE DECO

• Mesures: 333 x 333 x 15 mm. • Poids: 500 Grs. • Matériel: Poliéstileno antidérapant EVA stabilisé. • Hygiénique. Traité avec Sanitized, Antidérapant, Autofixation, Sans entretien.

CARACTERÍSTICAS TÉCNICAS PAVIMENTOS QUE PODEM SE ENROLAR DECO

• Dimensões: 333 x 333 x 15 mm • Peso: 500 grs • Material: Poliéstileno anti-escorregante EVA estabilizado • Higiénica. Esta tratada com Sanitized, Anti-escorregante, Montagem simple, Sem manutenção.

PAVIMENTO CONTINUO DE VINILO / CONTINUOUS VINYL FLOORING DALLAGE CONTINUU DE VINYLE PAVIMENTO CONTINUO DE VINILO

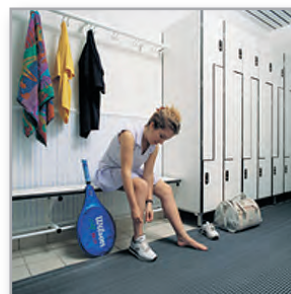
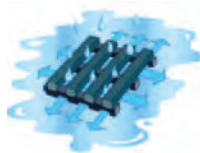
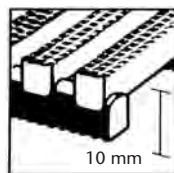

CARACTERÍSTICAS TÉCNICAS GENERALES

• Drenaje multidireccional sumamente efectivo.
• Aditivos: bactericidas y estabilizantes ultravioletas.
• Efectivo en zonas interiores y exteriores.
• Ideal para pies descalzos y a la vez antideslizante.
• Resistente y de gran duración.

FEATURES

• Very effective multidirectional drainage.
• Additives: antibacterial and ultraviolet stabilizers.
• Ideal for barefoot and non-skid at the same time.
• Resistant and long-term.

CARACTERISTIQUES TECHNIQUES GÉNÉRAUX

• Drainage multidirectionnel très efficace.
• Additifs: bactéricides et stabilisants ultraviolets.
• Idéal pour pieds nus et antidérapant au même temps.
• Résistant et grande durée.

CARACTERÍSTICAS TÉCNICAS

• Drenagem multidireccional muito efetiva.
• Adição: bactericidas e estabilizantes ultravioletas.
• Recomendado para zonas interiores e exteriores.
• Ideal para pés descalços e também é anti-escorregante.
• É muito resistente e de longa duração.

CERRADURAS / LOCKS SERRURES FECHADURAS



MOD. TELEC
COD. 90074



MOD. MCS1€
COD. 90036



MOD. CFALL
COD. 90026



MOD. CARC30
COD. 90020



MOD. PMET
COD. 90062

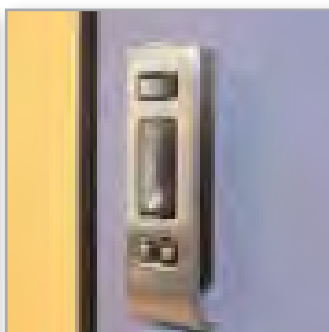

PROXY 1
COD. 90075



MOD. MMA1€
COD. 90038



MOD. PPOL
COD. 90025



MOD. CCOM40
COD. 90061



MOD. GPER
COD. 99775



MOD. COM4D
COD. 90500



MOD. CCOM45
COD. 90060



MOD. KITCE
COD. 90074

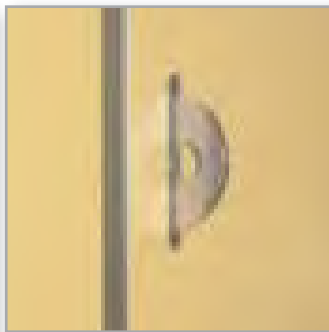

MOD. CERRCAN
COD. 90070



MOD. FALL
COD. 90050



MOD. CERRENC
COD. 90060



Plataforma logística PLA-ZA, C/. Palermo, 7
50197 ZARAGOZA (SPAIN)
Tels. (34) 976 505 488
Fax (34) 976 503 660 • Móvil (34) 696 655 771
comercial@megablok.com

www.megablok.com